

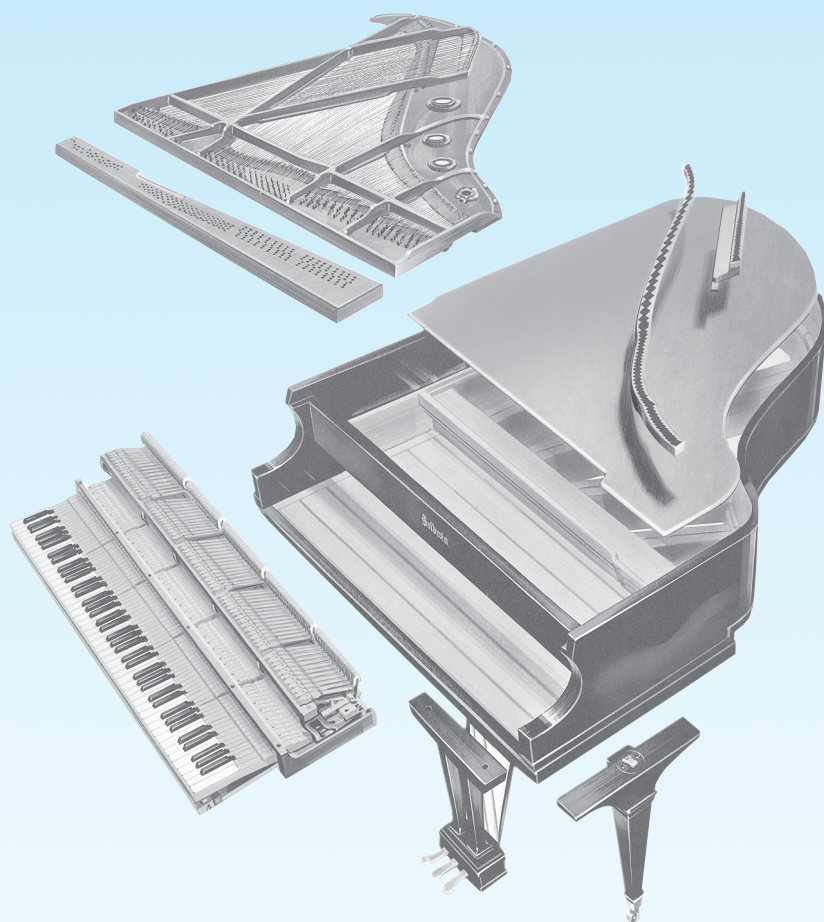

Phone: (818) 700-2100
FAX: (818) 700-2104 (24 Hours)
E-mail: Sales@pacificpiano.com

Website: www.pacificpiano.com

Hours:
8:30 a.m. to 5 p.m.
Monday thru Friday
(Pacific Time)



Quick Index

Action Parts	6-24
Bass Strings	31
Benches	41
Casters/Dollies	33-34
Caster Cups	33
Center Pins	28
Covers (Piano)	41
Dampp-Chaser	3-4
Felt/Cloth	35-36
Glues	38-39
Hammers	5
Key Board Services ..	24 & 40
Key Tops	39
Lubricants	39
Pedals	33
Pin Blocks	29
Polish	40
Punchings	35-36
Regulating Tools	26-27
Stringing Supplies	29-31
Tuning Tools	25-26
Tuning Pins	29
Wire	28-29

2021 – CATALOG #32

TERMS OF SALE

*WE ARE A “WHOLESALE TO THE TRADE”
SUPPLIER - YOU MUST BE A PROFESSIONAL PIANO
TECHNICIAN OR DEALER TO PURCHASE FROM US!*

MINIMUM ORDER IS \$25.00 (ALL ORDERS)

We will not be opening any new Net 30 day accounts

WE ENCOURGE CREDITCARD PAYMENTS

(VISA – MASTERCARD – AMEX –DISCOVER)

SHIPPING WILL BE VIA UNITED PARCEL SERVICE

*WE DO PROVIDE SOME ACCESSORIES TO CHURCHES,
SCHOOLS AND INSTITUTIONS – (PIANO COVERS, POLISH,
STAGE TRUCKS, BENCHES ETC.)*

Please contact us before ordering:

Email – sales@pacificpiano.com

Phone – 818-700-2100

Piano Life Saver Systems

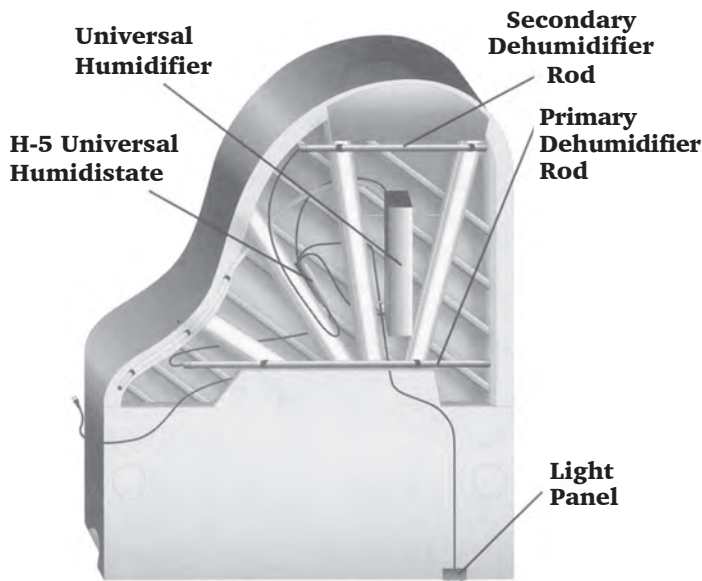

GRAND PIANO SYSTEMS

94 G6PS-38

Grand 6-Part System with one 36-inch, 38-watt primary Dehumidifier, one 24-inch, 25-watt secondary Dehumidifier, a Universal Tank Humidifier, and Humidistat. **THIS SYSTEM FITS ALL GRAND PIANOS.**

94 G6PS-50

Grand 6-Part System with one 48-inch, 50-watt primary Dehumidifier, one 24-inch, 25-watt secondary Dehumidifier, a Universal Tank Humidifier, and Humidistat.

94 G7PS-38

Grand 7-Part System with one 36-inch, 38-watt primary Dehumidifier, one 24-inch, 25-watt secondary Dehumidifier, 2 Universal Tank Humidifiers, and a H-5 Universal Humidistat.

94 G7PS-50

Grand 7-Part System with one 48-inch, 50-watt primary Dehumidifier, one 24-inch, 25-watt secondary Dehumidifier, 2 Universal Tank Humidifiers, and a H-5 Universal Humidistat.

SMART BRACKET



94 SBE Smart Bracket

Causes standard Humidifier Bar to turn off in the absence of moisture. Use only with complete Grand or Vertical Systems.

Piano Life Saver Systems

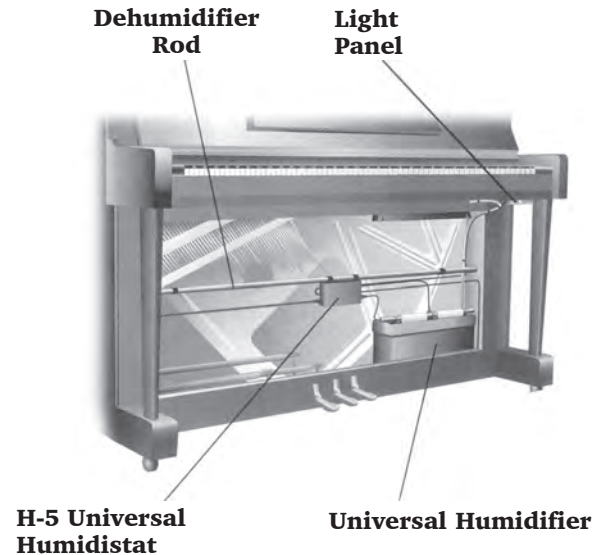

VERTICAL PIANO SYSTEMS

94 5PS-50

5-Part System with one extendible 48-inch, 50-watt Dehumidifier, one Universal Tank Humidifier and Humidistat.

UNIVERSAL HUMIDIFIER KIT

94 HM-5

Complete Humidifier Kit for Upright and Grand Pianos up to 6'10". Includes a H-5 Humidistat, Low Water Sensor, Two-light Panel, Moisture Distribution Baffle, Watering Can and Watering Tube. 8-ounce Humidifier Treatment included.

HUMIDISTATS

94 HD Dual Automatic Humidistat.



If you don't see a Dampp-Chaser Product you are looking for — just ask!

818-700-2100

Humidity Control Products

HUMIDIFIER TREATMENT

Humidifier additive formulated to reduce mineral build-up. Keeps watering tube clean and clear. Prolongs humidifier pad effectiveness.



94 HT 94 HT16

- 94 HT 7.5 oz.
- 94 HT16 16 oz.
- 94 HT 12PK
- 94 HT16 12PK

HUMIDIFIER PADS

Pads should be replaced twice a year, or when mineral deposits render them ineffective.



94 UHP-4 4 Replacement Humidifier Pads (white), 1 Black and 1 Clear Liner for Universal newer Tank. .

94 UHP-48 48 Replacement Humidifier Pads (white), 12 Black and 12 Clear Liners for Universal newer Tank.

WATERING KIT

Includes water can and fill tube.

For either grand or upright.

94 WK Universal Watering Can - with fill tube.

94 WC Universal Watering Can only.



FAX US YOUR ORDER (818) 700-2104

DEHUMIDIFIERS

94 48-50A 48" Damp-Chaser with extensions - 50 watts.

94 48-50 Grand 48" Damp-Chaser without extensions - 50 watts.

94 48-35A 48" Damp-Chaser with extensions - 35 watts.

94 48-35 Grand 48" Damp-Chaser without extensions - 35 watts.

94 48-25A 48" Damp-Chaser with extensions - 25 watts.

94 48-25 Grand 48" Damp-Chaser without extensions - 25 watts.

94 48-15A 48" Damp-Chaser with extensions - 15 watts.

All 48" rods (except 15 watt) must be installed with a humidistat.

94 36-38 36" Damp-Chaser - 38 watts.

94 7F 36" Damp-Chaser - 25 watts.

94 5F 36" Damp-Chaser - 15 watts.

94 24-25 24" Damp-Chaser - 25 watts.

94 5RF 24" Damp-Chaser - 15 watts.

94 3F 18" Damp-Chaser - 12 watts.

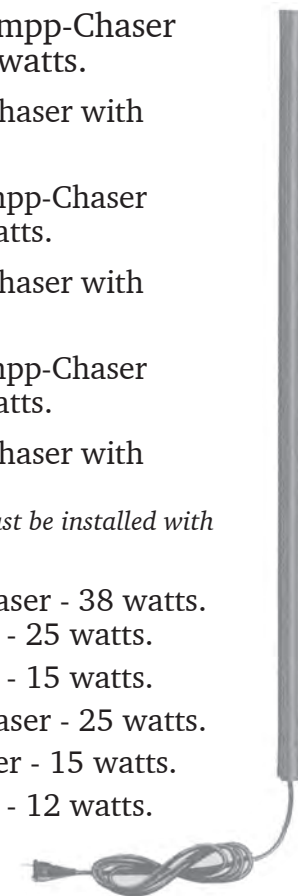

94 3P50A - 3 HD Humidistats and 3 48" 50 watt Dehumidifiers for Grands and Uprights

ELECTRICAL OUTLET

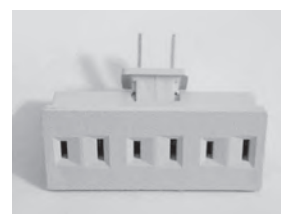

94 TO Triple Outlet.

Online ordering...

www.pacificpiano.com

FAX US YOUR ORDER (818) 700-2104

*Many Items are Discontinued.
Looking for a Tool You Don't See?
Call and Ask Us - Limited Stock
May Still Be Available On
Discontinued Items.*

Only available at Pacific Piano Supply Co.

“Gold Label” Grand Hammers



Light weight, mahogany moulding, resilient English felt...

EASY TO VOICE.

Will not increase the touch weight.

Available in all lengths: Weights (15-17-19 lb.)

A hammer fashioned after the older American style pianos. Fits Steinway, Mason & Hamlin, Knabe, Baldwin and Chickering Grands and all name brand Grand Pianos.

Available exclusively at Pacific Piano -

Let us help you select the ideal hammer for your purpose.

NOTE: Samples are not required for boring on STEINWAY Grand Pianos Only. Specify the Model Number (S, M, L, O, A, B, C, or D) and the Shank Type (New TOKIWA, Original New York, or Original German). We will bore and shape your hammers to an excellent fit using our factory specifications.

ALL our Hammers have Mahogany Moulding

3 Types of Pacific “Gold” Grand Hammers

Pacific Golds		02 type	2-7/8" or 73mm Treble	
				Per Set
Steinway	19 Lb	02 900	20 Bass - B-A	
10.7mm	19 Lb	02 926	26 Bass - SML0	
Wide				
Pacific Golds		03 type	3-1/8" or 79mm Treble	
				Per Set
10.3mm	17 Lb	03726	26/30 Bass -	
Wide			6 Ft. Grands	
	19 Lb	03 900	20 Bass-Concert D	
		03 926	26/30 Bass	
Pacific Gold		03 Longs	3-1/4" or 83mm Treble	
				Per Set
		03 726L	26 Bass Long	
			(Small Grands)	

CUSTOM BORING & SHAPING

01 BS Boring & Shaping

Set

We will be bore and shape hammers to your specification from samples provided. Send the entire shank & flange with the hammer attached. No warranty is given on verbal or written specifications only. We guarantee 100% satisfaction when samples are provided.

Send First & Last Bass, First Tenor & Last Angled Tenor and Highest (#88) Hammer.

Tell us Tails Shaped, or Not Shaped.

Pre-hanging Hammers on Our Shanks

01 1 Hammers - Send us the end hammer of each section (leave glued on original shank and flange). We will pre-hang your NEW Hammers on NEW Shanks and Flanges - you will get a perfect set - ready to screw on and regulate.

UPRIGHT HAMMERS

03 200 Economy Hammers 14 lb. 26/30 Bass. No under felt Hornbeam Molding. **Set**

Best Quality Felt on selected mahogany mouldings. Underfelted. Not Reinforced.

Pacific Gold Upright

03 400 14 lb. 26/30 Bass **Set**
03 600 16 lb. 26 Bass **Set**
01 BU Upright Boring **Add**

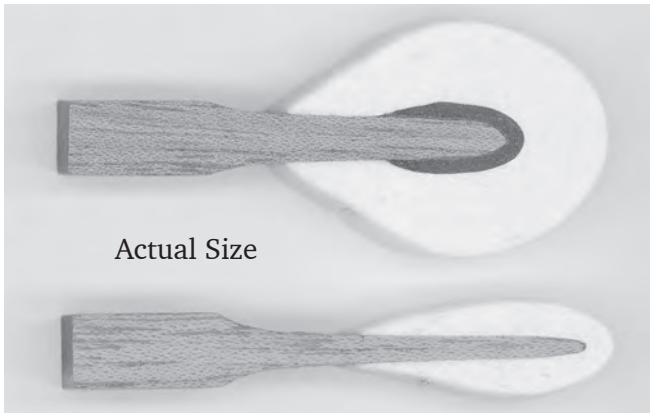

CUSTOM UPRIGHT BORED HAMMERS:
 When ordering custom bored hammers, please submit the following samples; First & Last of Bass Section, First Angled Tenor Hammer, Last Angled Tenor Hammer, and Highest (#88) Hammer.
PLEASE INCLUDE SHANK AND BUTT, DO NOT PULL HAMMER FROM SHANK.
 Always number your samples according to the Key Number. We will return samples with your new set.

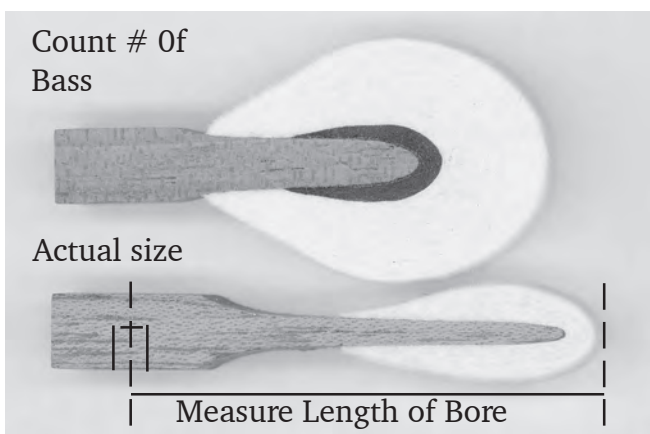

TO ORDER READY-BORED HAMMERS:
 Before ordering a new set, examine the old hammers to see if the lower tenor hammers (those just above the bass), are bored Straight, or at an Angle. If Tenor Hammers are Angled, specify TYPE A. If hammers are straight above the Bass, specify TYPE B
MEASURE LENGTH OF #88 HAMMER
 (From the Center of the Shank, to the Tip of the Hammer)
 Three Lengths available: 2 3/8", 2 7/16", 2 1/2". **COUNT NUMBER OF BASS HAMMERS** (Sets 26-30 Bass).

NEW! Tokiwa Action Parts

These are the highest quality TOKIWA Grand Action replacement parts, made to our exact specification. Pacific is the sole authorized US distributor of these fine parts.

See Pages 8 thru 18 for exact scale drawings

WIPPENS -

TOKIWA Wippens are made to match the originals, the best quality replacement parts available.

Part No.	Description	Set
05 001	TS Steinway NY Style	
05 001HM	TSH Steinway Hamburg Style	
05 002	TR Renner Style	
05 018	TMH Mason & Hamlin Style	
05 020	TUW Universal, with Detached Heel	
05 021	TBK Universal (Knabe/Chickering, Baldwin) No Flange	
05 020NF	TUW Wippen (no Flange) specify heel	
05 031	TY Wippens (Yamaha - Young Chang & other Asian pianos).	
05 032	TK Wippens (Old Kawai)	
05 12F	Baldwin Wippen Flanges	
05 13F	Knabe - Chickering Flanges	
05 18F	Mason & Hamlin Flanges	
05 20F	Standard Universal Flanges	
05 011WS	Steinway Wippen Flanges	
05 020HL	Wippen Heels - long 20mm	
05 020HS	Wippen Heels - short 16mm	
05 020HXS	Wippen Heels - X-short 12mm	

GRAND SHANKS & FLANGES

All shanks have the same dimensions from knuckle core to the center pin. All are bushed with the finest quality "White Core" bushing cloth.

Part No.	Description	Set
05 003	New York Steinway Style TS	
05 004	Hamburg Steinway Style TSH	
05 005	Renner Style SH & TR Flange	
05 005BL	Shank with unbored Flange	
05 008	Shank with adjustable slotted Flange	
05 006	W,N&G, Mason & Hamlin plus many others	
05 007	A Shank & Flanges Misc.	
05 007N	A Narrow SH & Flanges 11mm	
05 009	AC Aeolian SH & Flanges Mason & Hamlin and others	
05 010G	Shanks only, No Flanges	
05 015	Baldwin old-bore OB	
05 016	Baldwin new-bore NB	

Shanks & Flanges continued....

- 05 017** YT Yamaha Type SH & Flanges,
Fits Young Chang & others
- 05 017W** YT Old Style Yamaha Type
Shanks & Flanges
- 05 033** KW Old Style Kawai SH &
Flanges
- 05 019** Knabe (some models) KN

MISCELLANEOUS ACTION PARTS

Part No.	Description	Set
05 012	Knuckles, genuine buckskin	
05 013	Reg. Backchecks with wires	
05 013TS	Backchecks with wires, Steinway Style	
05 014	Reg. Backchecks, no wires	
05 014TS	Backchecks, no wires, Steinway Style	
05 U505T	Upright Butts & Flanges	
05 U508T	Brass Rail Butts	
05 U509T	Upright Wood Flanges	
05 532T	Upright Hammer Shanks (Set) 5.5mm diameter	
05 905	Upright Damper Blocks	
05 601	Grand Damper Action	
05 189T	Grand Damper Felts	
05 903S	Grand Flange Screws	
05 904	Grand Let-off Buttons - Dowel type	
05 901	Hammer Rest Rail Bolt and Nut set	
05 906	Grand Flange Screw/Washers	
42 670B5	Black Caster Cups	
42 670W5	Brown Caster Cups	
42 670I5	White Caster Cups	

Online ordering...
www.pacificpiano.com

*Many Items are Discontinued.
Looking for a Tool You Don't See?
Call and Ask Us - Limited Stock
May Still Be Available On
Discontinued Items.*

NEW! Grand Damper Felts



05 189T Grand Damper Felts,
Complete Set



05 189B Grand Damper Felts, with Red Back
Treble Set

05 189A Grand Damper Felts, without Red Back.
Treble Set

NEW! Grand Damper Felt Strips

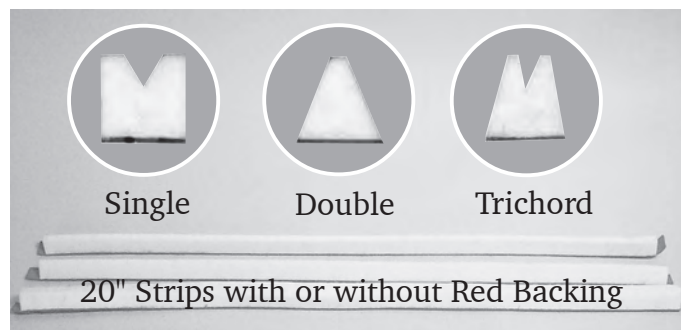

**Sold in 20" Strips with Red Backing.
Single, Double, or Trichord.**

- 05 183BS** Red Back Single
- 05 183BD** Red Back Double
- 05 183BT** Red Back Trichord

**20" Strips without Red Backing. Single,
Double, or Trichord.**

- 05 183AS** Without Red Back Single
- 05 183AD** Without Red Back Double
- 05 183AT** Without Red Back Trichord

Older American Grand Pianos

Grand Wippens

Choose separate Heel and Flange to **CREATE** almost any wippen

TBK Universal

Create...
Knabe - Chickering - Baldwin

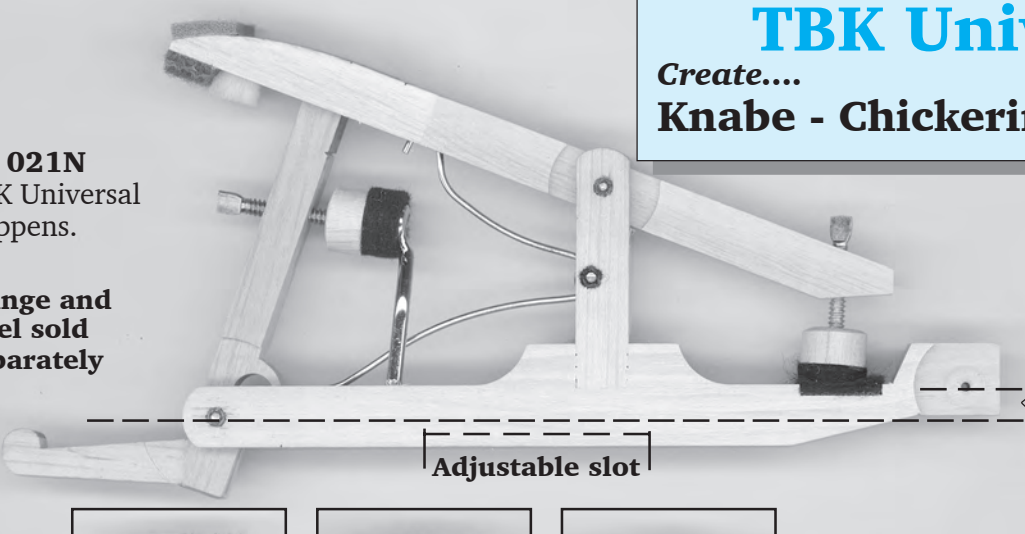

05 021N
TBK Universal
Wippens.
Set

**Flange and
Heel sold
separately**

**And many
other pianos**

**4mm rise of
Wippen Flange
above Jack
center.**

LONG
20mm

SHORT
16mm

**EXTRA
SHORT**
12mm

**Heels
sold
separately**

05 021HL Wippen Heels - long 20mm

05 021HS Wippen Heels - short 16mm

05 021HXS Wippen Heels - X-short 12mm

Knabe

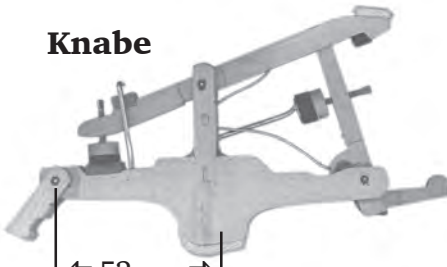

↔ 53mm ↔

Knabe

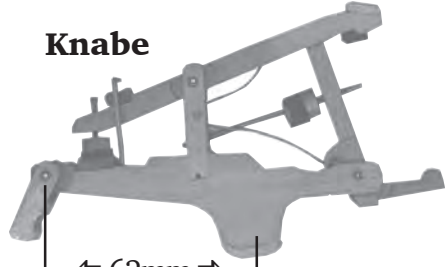

↔ 62mm ↔

Baldwin Type

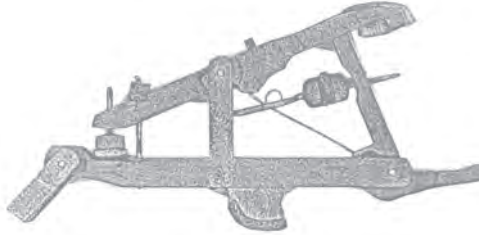

New slotted type heels allows adjustment from 53mm to 62mm

Knabe Types Use 13-F Flange

Baldwin Type
Old Style with machine screw rail
Use 12-F Flange

- How to Order:**
1. Check your original sample Wippen for position of Wippen Flange in relation to Jack Flange. If Wippen Flange is 4mm above Jack Flange, use **TBK** Wippen body (pictured above). If Wippen Flange and Jack Flange are in line, use **TUW** (05 020).
 2. **CHOOSE MATCHING WIPPEN FLANGE** (Below): #**13F** fits Knabes; #**15F** Chickering; #**12F** fits Old Baldwin Type with machine screw rails; #**14F** fits Chickering (replaces Brass Type); #**18F** Long flange; #**19F** fits Aeolian; or #**20F** Standard Flange.
 3. **CHOOSE WIPPEN HEEL** (Above): 20mm Long; 16mm Short; or 12mm Extra Short.
 4. **PLACE YOUR ORDER:** Example - 1 set TBK Wippen bodies, 1 set Baldwin Flanges (12F) and 1 set Extra Short Heels. Makes Baldwin Old Style Wippen as pictured Above.
 5. Sets are **NOT** assembled, #18½ center pins are provided to install Wippen Flanges. Glue Heels after Wippens are mounted, with action upside down.
 6. We can match your sample and pre-assemble the set. Please call for quote.

Older American Grand Pianos

Grand Wippens

TUW Universal Wippens

05 020 TUW Universal Wippens with Flange

Jack & Wippen
Flange centers
in straight line.

05 020
COMES WITH
FLANGE 05 20F
ATTACHED

05 020NF
TUW Universal
Wippen **NO
FLANGE** (Body
only).

**Both Heels
and Flanges
sold
separately.**

Heels
sold
separately

LONG
20mm

05 021HL

SHORT
16mm

05 021HS

EXTRA
SHORT

12mm

05 021HXS

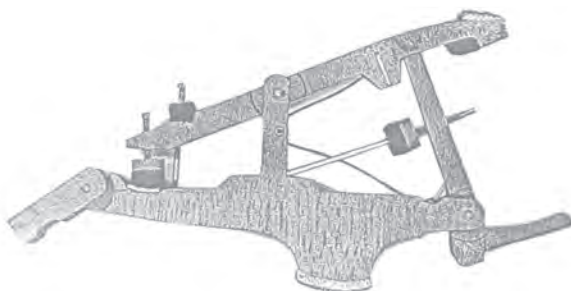

Chickering Types

Use 14F Flange or 15F Flange

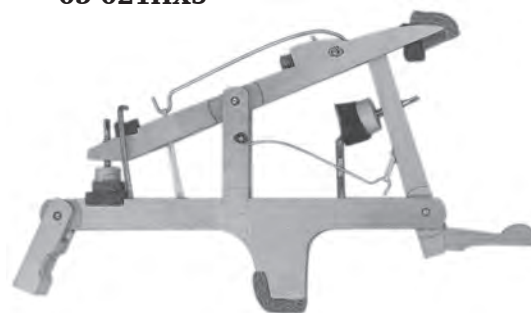

PrattReed Types

Use 20F Flange



05 12F

Baldwin Wippen
Flanges

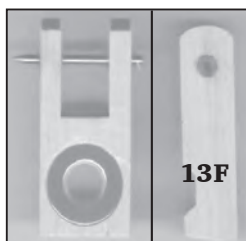

05 13F

Knabe Whippen
Flanges

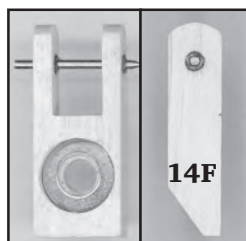

05 14F

Chickering Flange
(replaces Brass Type)

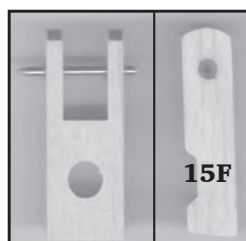

05 15F

Chickering Wood Rail

Create different
wippens for
many other
pianos

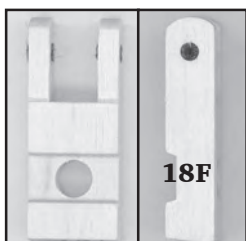

18F

05 18F (long)
Mason & Hamlin
Flanges

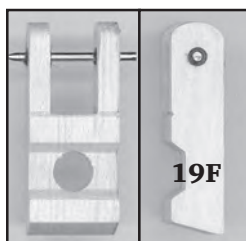

19F

05 19F
Aeolian Flanges

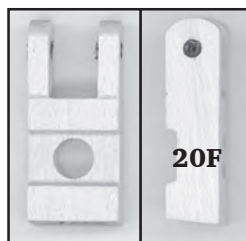

20F

05 20F
Standard Flanges - use
for many other pianos

Hammer Rest Rail Bolt and Nuts

For use when replacing Bumper
type whippens with Universal

05 901 Hammer Rest Rail Bolt.....
Set of 5 pieces (wood rail not included)



Older American Grand Pianos

GRAND SHANKS & FLANGES — (U.S.A.)

NEW YORK STEINWAY TYPE

TS



05 003 TS Grand Shanks & Flanges



TS

WESSEL, NICKEL & GROSS TYPE (BOSTON MASON & HAMLIN) + MANY OTHERS

C



05 006 C Grand Shanks & Flanges



C

FITS SOME KNABES & CHICKERING & OTHERS *AN Narrow Flange 11mm. For Chickering "Brass Flange", Chickering "Quarter Grand" and some Knabes.

A

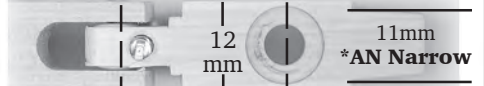

05 007 A Grand Shanks & Flanges (as shown)
05 007N AN Narrow Shank & Flange, 11mm

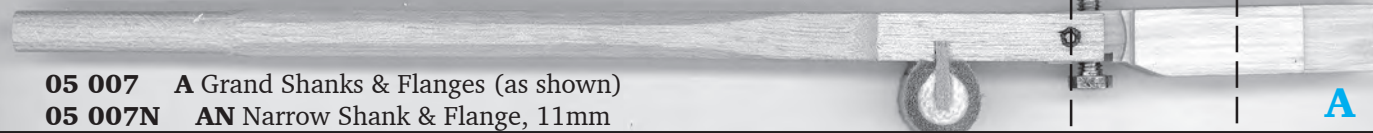

A

FITS AEOLIAN, MASON & HAMLIN and others

AC



05 009 AC Grand Shanks & Flanges



AC

OLD STYLE BALDWIN TYPE (Has deep countersink for machine screw)

OB



05 015 OB Grand Shanks & Flanges



OB

NEW BALDWIN TYPE

NB



05 016 NB Grand Shanks & Flanges



NB

KNABE TYPE

*KN Narrow Flange 11mm.

K

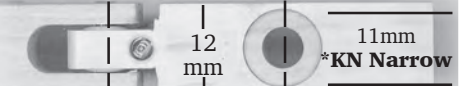

05 019 K Grand Shanks & Flanges (as shown)
05 019N KN Narrow Shank & Flange, 11mm

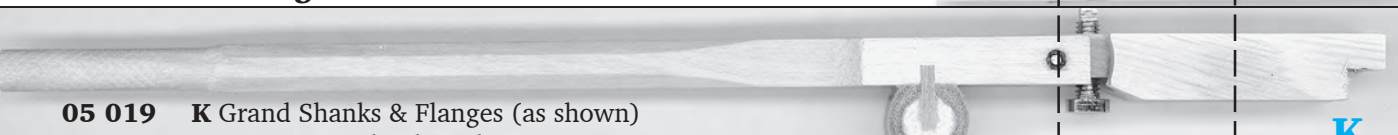

K

European and Asian Type Grand Pianos

GRAND SHANKS & FLANGES — (Imports)

HAMBURG STEINWAY TYPE	TSH	
05 004 TSH Grand Shanks & Flanges		TSH
RENNER TYPE TR Adjustable Type TA	TA	
WITH ADJUSTABLE FLANGE		RENNER TYPE
05 008 Grand Shanks & TA Adjustable Flanges 05 005 Grand Shanks & TR Renner Flanges		TA TR
OLDER KAWAI TYPE	KW	
05 033 KW Grand Shanks & Flanges		KW
YAMAHA TYPE FITS YOUNG CHANG & MANY OTHER ASIAN IMPORTS		YT
05 017 YT Grand Shanks & Flanges		YT
YAMAHA OLD TYPE FITS YOUNG CHANG & MANY OTHER ASIAN IMPORTS		YT
05 017W YT Grand Shanks & Flanges		YT

GRAND SHANKS WITHOUT FLANGES

SHANK ONLY	17mm	
05 010G Grand Shanks ONLY		GRAND KNUCKLES (PER SET)

Wippen Flange Screws	Hammer Flange Screws
05 903W	05 903F
05 900F Flange Washers (set) Not Pictured.	

GRAND KNUCKLES (PER SET)
05 012
Grand Knuckles Set

European and Asian Type Grand Pianos

Hamburg Steinway Type

With adjustable Assist Spring
05 001HM Steinway Grand Wips (Hamburg)

↔ Adjustable 5mm ↔

Angled Heel
05 001-2

Straight Heel
05 001-1

Enlarged view of adjustable assist spring

Heel comes unassembled (Heels sold separately)

HAMBURG STEINWAY TYPE

TSH

05 004 TSH Grand Shanks & Flanges

TSH

Steinway Grand Parts and Accessories...

Steinway Type Backchecks

Replaces heads and wires on both Hamburg and NY pianos.

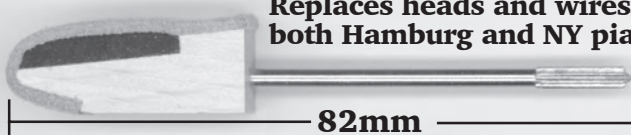

05 013X Backchecks - Red Underfelt - Escaine

Hammershank Stop Felt

For replacing wippen shank-rest felts



Side View

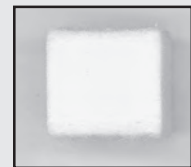

05 48177A

10mm high

05 48177AT

13mm high

Comes in two thicknesses



05 48155S Felt Punching for Steinway Regulating Button. 11mm



GRAND KNUCKLES

(Escaine)

05 012

Grand Knuckles Sold by the Set Only.

Wood Regulating Buttons



05 48156-1 Standard Wood Regulating Button 11mm. 5mm thick



05 48156-2 Tall Wood Regulating Button 11mm. 10mm thick

See Page 18 for...

Damper Action Replacement Kit for Steinway (both Short-arm and Teflon styles)

European and Asian Type Grand Pianos

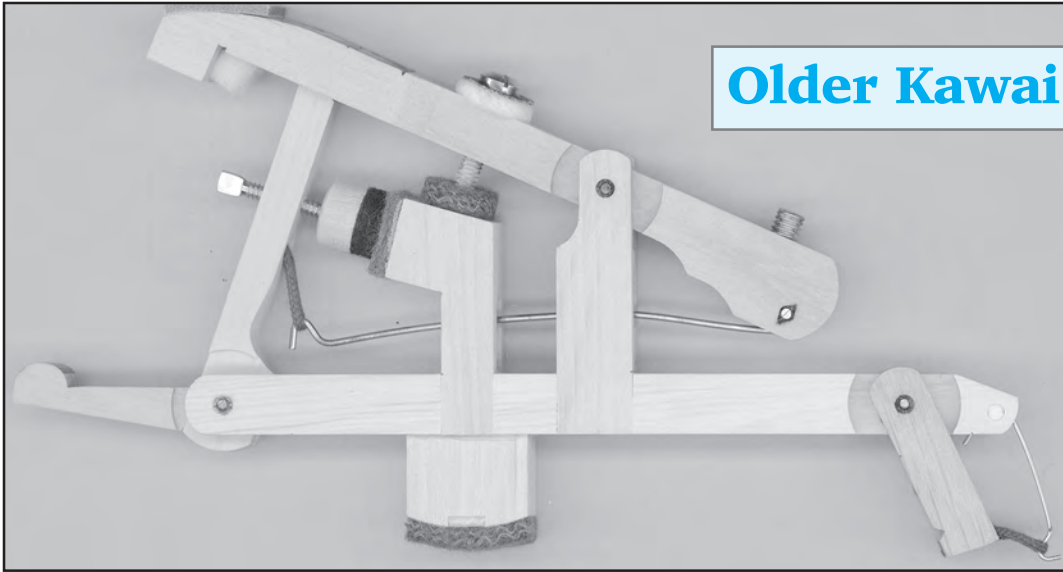

Older Kawai Type Wippen

05 032 Grand Wippen

OLDER KAWAI TYPE

KW

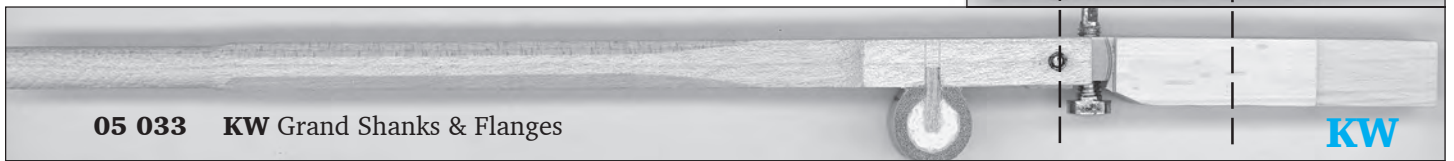

05 033 KW Grand Shanks & Flanges

KW



Steinway Type Backchecks (Original NY Size)

05 014TSR Backchecks - red underfelt - Escaine



Steinway Type Backchecks with wire

05 013TSR Backchecks - red underfelt - Escaine

82mm

Steinway Type Backchecks - New Style

Replaces heads and wires on newer Hamburg & NY Pianos

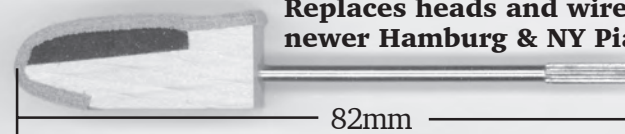

05 013X Backchecks - red underfelt - Escaine

82mm



Regular Type Backchecks

05 014R Backchecks - red underfelt - Escaine



Regular Type Backchecks

05 013R Backchecks - red underfelt - Escaine

91mm

Other Grand Parts & Accessories



Grand Let-off Buttons

05 904 Grand Let-off Buttons..... Set

Sold by Sets only



Chickering Top Flange

Replacement Set. Pin on original Lever. For "Screw-in" threaded Damper Wires.

05 605
Top Flange

Wippen & Shank for "Brass Flange" Type Chickering Grand
See pages 11 & 12

Other Grand Parts and Accessories

Tokiwa Grand Damper Action Replacement Kits

Includes Tray - Pivot Pins - Tray Felt Assist Springs and Upstop Rail Felt. Includes instructions.

Replaces entire Back Action.

05 601 Replacement Kit. For Teflon and "Short-Arm" Styles.

05 601N Replacement Kit. For Steinway old "Rigid-tab".

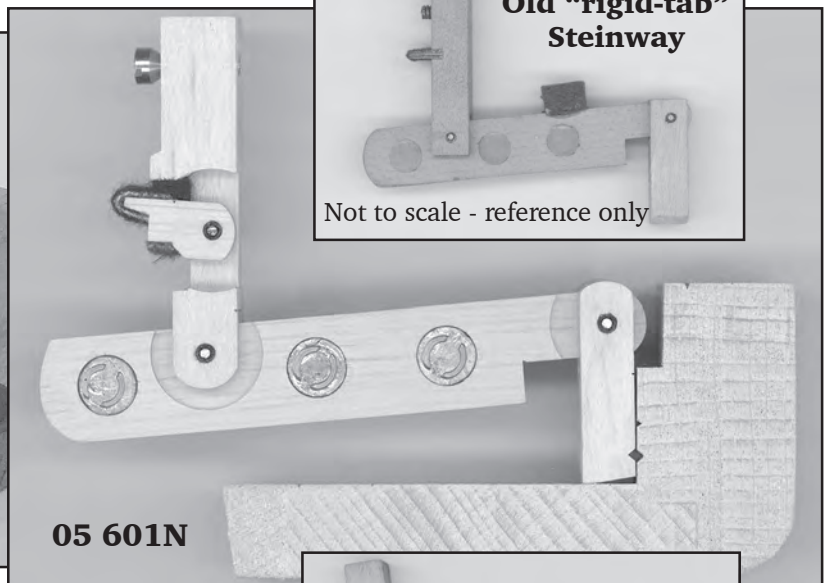
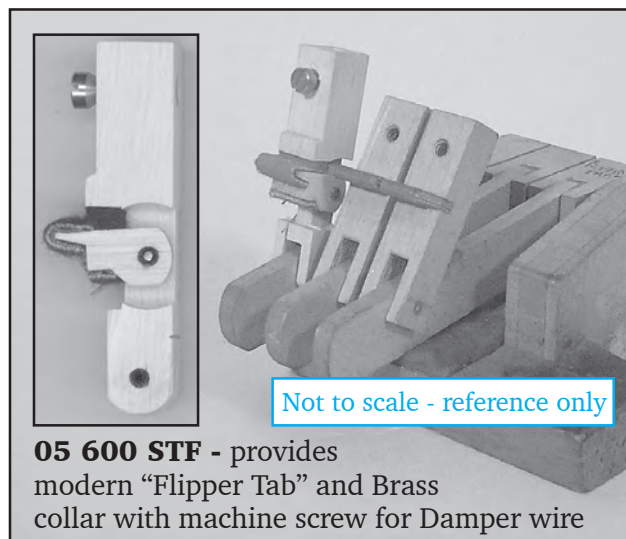
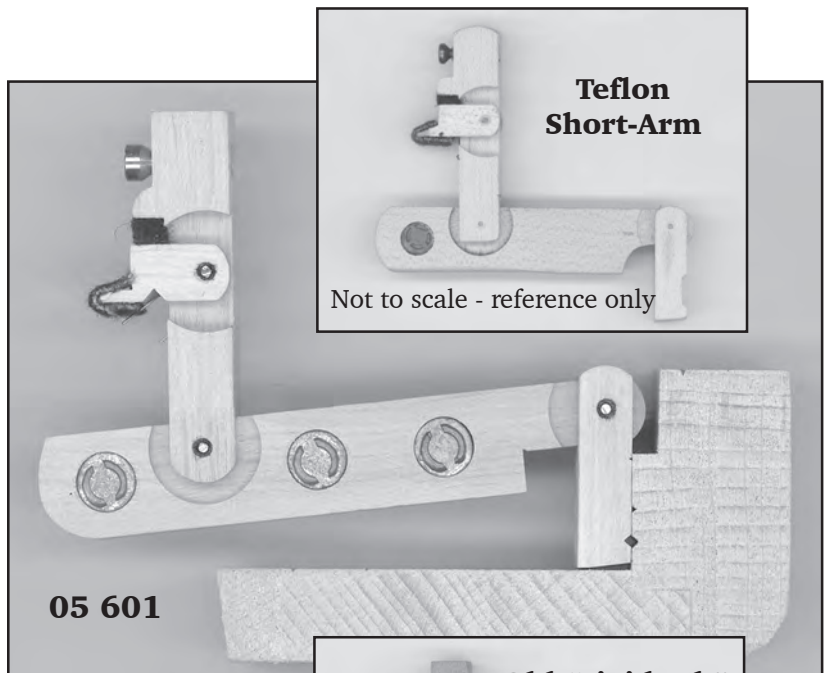

05 600 STF Steinway Top Flange Only. Replace Top Flanges only on old "Rigid Tab" Steinways.

05 605 MH Mason - Hamlin WNG Replacement Kit - includes New Tray and all hardware.

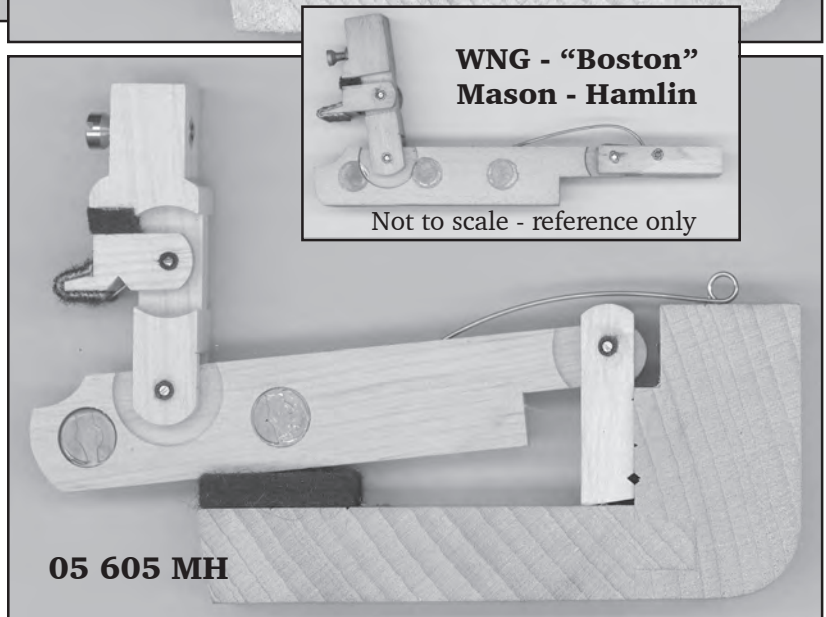

Damper Tray Lifter Felt

05 48601 Damper Tray Lifter Felt (replaces Steinway Tray Felts)



Grand Damper Felts

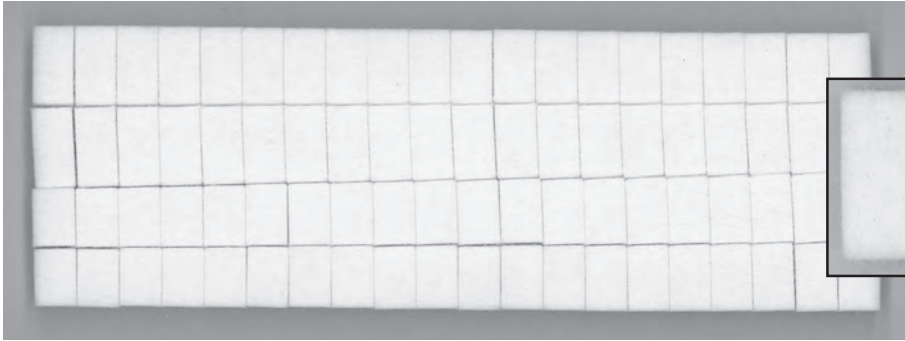

Grand Damper Felts

05 189A Flat Damper Felt.

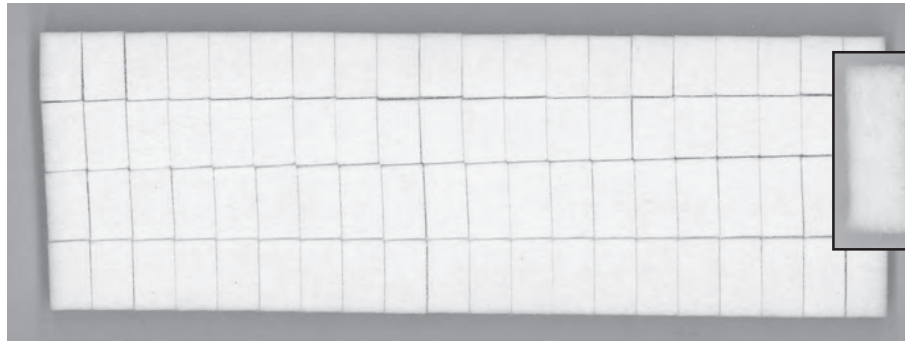

05 189B Flat Damper Felt with Red backing

05 189T Grand Damper Felts, complete Set.

Grand Damper Felt Strips

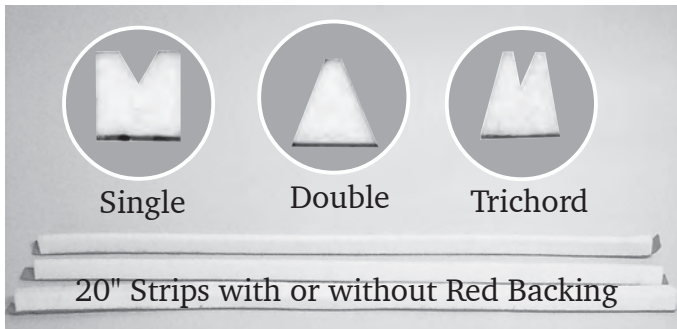

Single

Double

Trichord

20" Strips with or without Red Backing



- Fits 20 to 33 Bass
- Pre Cut
- Sold complete set

Felt Strips w/out Red Backing

05 183AS W/out Red Back Single

05 183AD W/out Red Back Double

05 183AT W/out Red Back Trichord

Strips with Red Backing

05 183BS Red Back Single

05 183BD Red Back Double

05 183BT Red Back Trichord

Felt Punching



11mm

05 48155S

Felt Punching for Steinway Regulating Button.

Wood Regulating Buttons

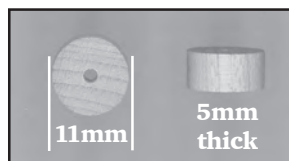

11mm

5mm thick

05 48156-1 Standard Wood Regulating Button 11mm. 5mm thick

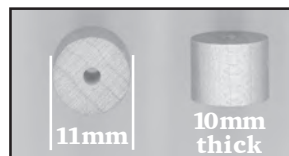

11mm

10mm thick

05 48156-2 Tall Wood Regulating Button 11mm. 10mm thick

Full Size American Upright Pianos

05 U505T Wood Flange Upright Butt. Set.



05 U508T Brass Rail Butts.. Set

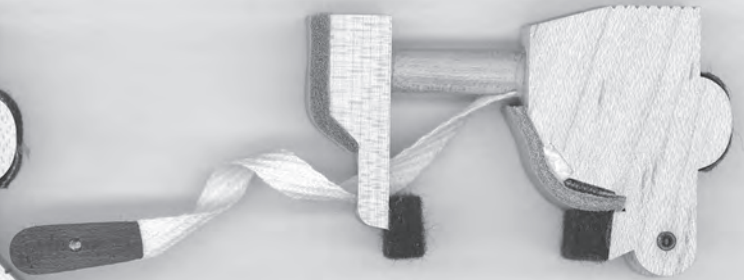

Upright Action Parts

05 U509T Wippen & Butt Flanges Set

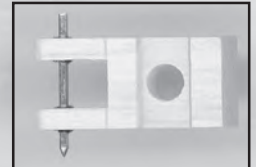

Upright Jacks & Flanges



05 U525J Upright Jack only. Sold by the Set.

05 U526-1 Upright Jack and Flange. Sold by the Set Only.

05 U525J

05 U526-1

Recommended

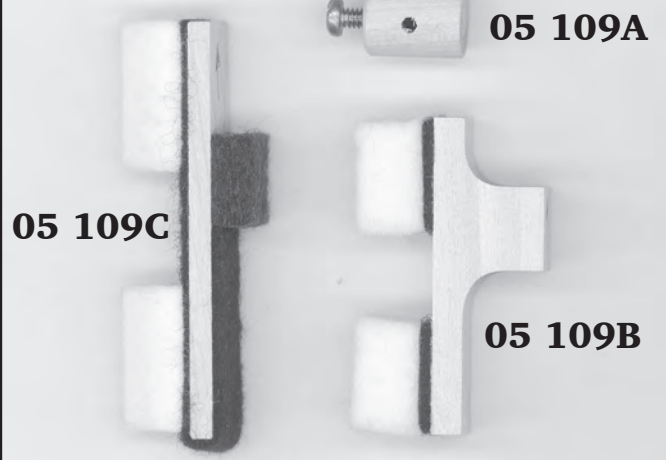

05 109A

05 109C

05 109B

Round Type Damper Blocks

Damper Blocks, Round

05 109A Damper Blocks, Round - Set.

Treble Damper Heads

05 109B Treble Damper Heads - Set.

Bass Damper Heads

05 109C Bass Damper Heads - Set

Upright Damper Lever



05 U513 Upright Damper Lever (Full size)

Spinnet/Console - Compact Action

Replaces Plastic Action Parts

Compact Upright Wippen

05 U3762 Upright Wippen – Compact Type - Set.



Spinnet Damper Flange

Compact



05 U3717W Spinnet Damper Flange - Set

Wippen & Butt Flanges

05 U509T Wippen & Butt Flanges - Set

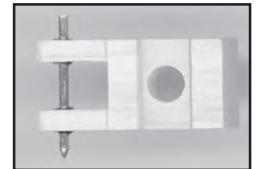

Upright Damper Lever – Compact

05 U3786 Upright Damper Lever – Compact Type - Set



Jack and Flange Compact

05 U3790 Compact Jack and Flange - Set



Wood Elbows

05 U3775 Wood Elbows Set.

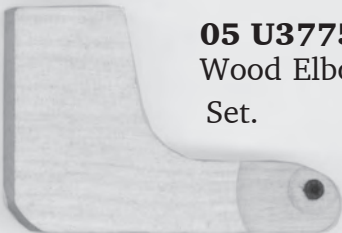

Compact “S-2” Type Upright Butt

05 U610 “S-2” Type Upright Butt

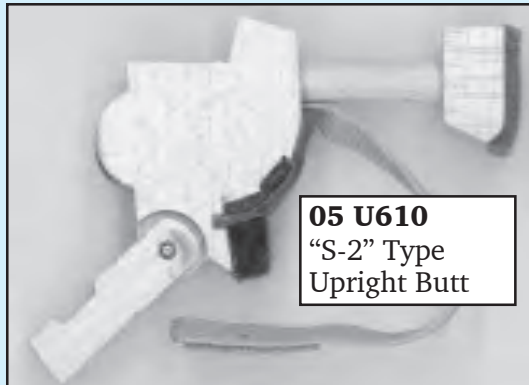

05 U530



05 U530X

Upright Back Checks

05 U530 Upright Back Check with wire. Set.
05 U530X Upright Back Check no wire. Set.

Other Upright Parts and Accessories

Yamaha and Kawai Type Butts & Flanges

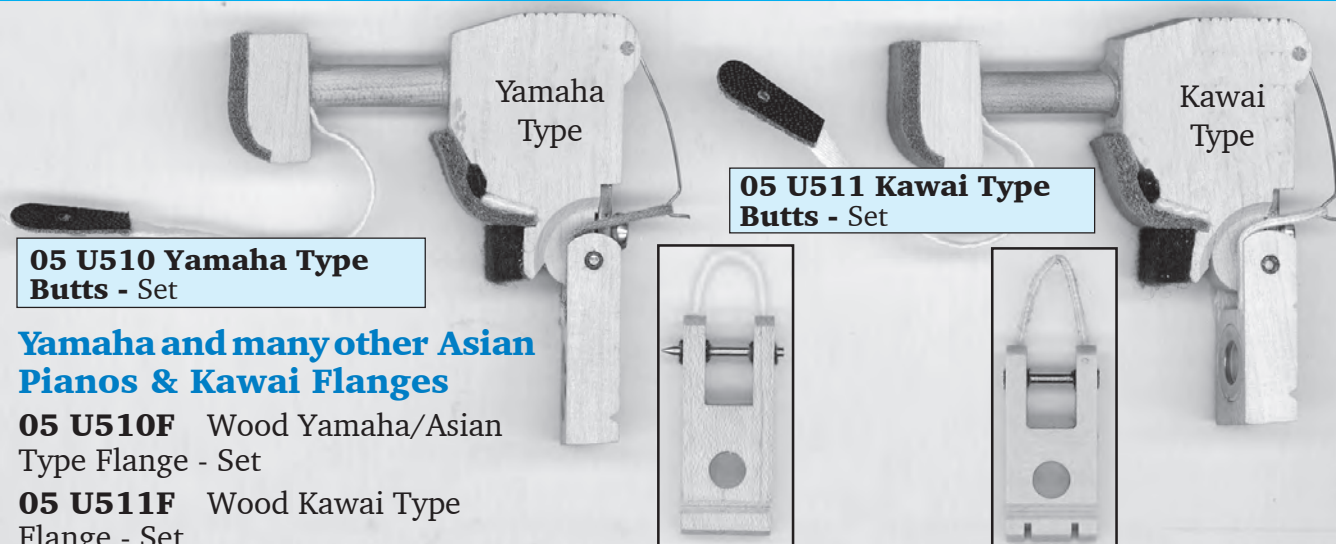

05 U510 Yamaha Type Butts - Set

05 U511 Kawai Type Butts - Set

Yamaha and many other Asian Pianos & Kawai Flanges

05 U510F Wood Yamaha/Asian Type Flange - Set

05 U511F Wood Kawai Type Flange - Set

Felt Punching

For Upright Regulating Botton



05 48155C
Felt Punching

Upright Back-stops

(catchers)



05 501
Upright Backstops.

Steinway Upright Dowel Type Capstan



05 U520
Upright Dowel Type Capstan

Regulating Button Upright, wood 9mm



05 48450W
Wood w/o felt
9mm x 5mm thick.

Round Type Damper Blocks

Recommended

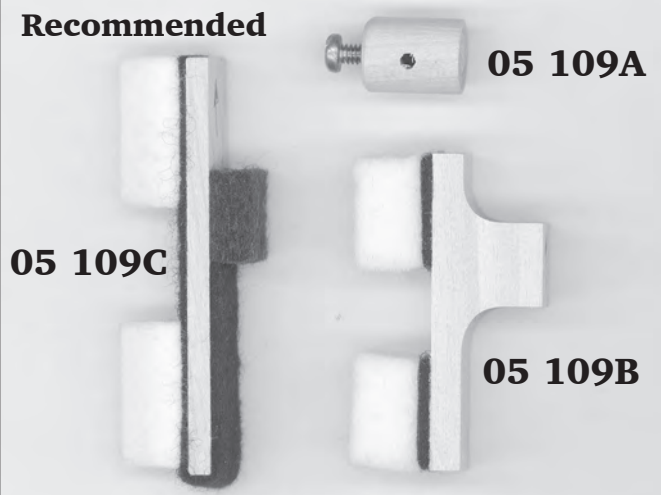

05 109A

05 109C

05 109B

Tokiwa Upright Treble Damper Felt

05 185BL Upright Treble Damper Felt. Complete Set



Actual Size

Watch for upcoming New Tokiwa quality products...

Damper Blocks, Round

05 109A Damper Blocks, Round - Set.

Treble Damper Heads

05 109B Treble Damper Heads - Set.

Bass Damper Heads

05 109C Bass Damper Heads - Set

Steinway Style Upright Parts

Steinway style Upright Parts

Old Steinway Upright F Wippens

05 1TF Steinway F Wippens

F

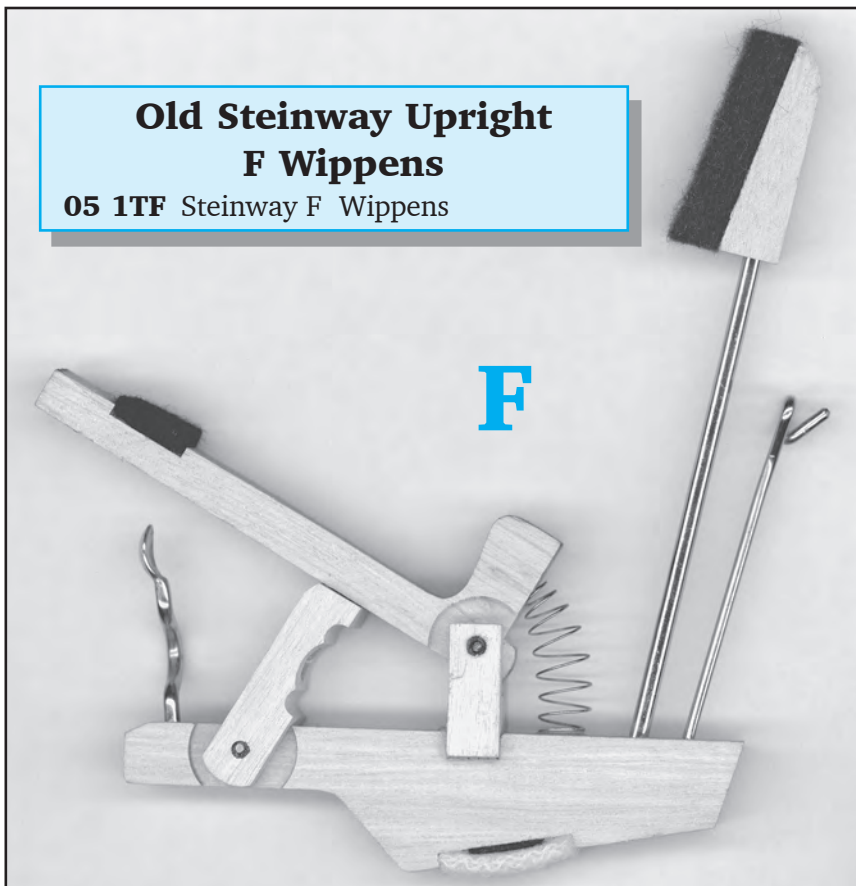

Damper Levers

05 103 Steinway Style Upright
Damper Lever with Plate. Sold by
Set only.

To Replace
Damper Blocks.
See page 16, 18 -
05 109A, 05 109B
and 05 109C.

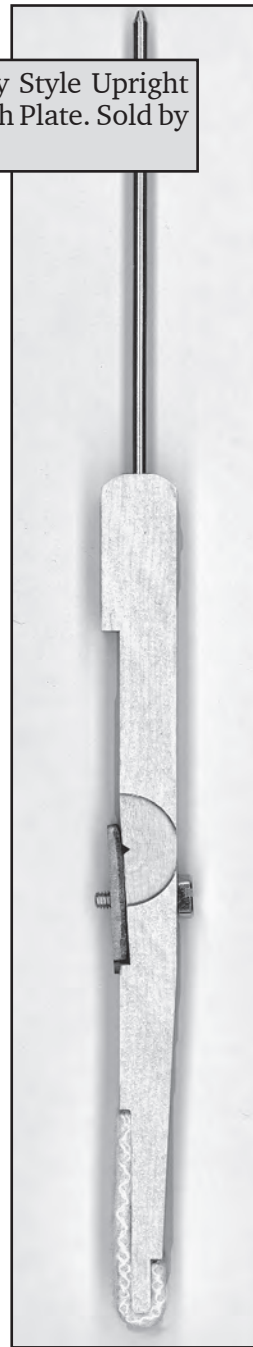

V

Old Steinway Upright V Wippens

05 1TV Steinway V Wippen

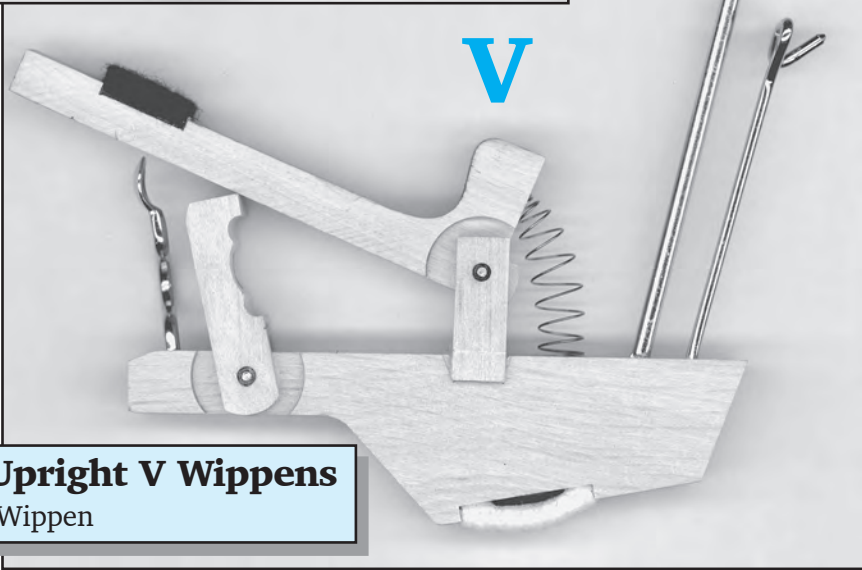

Butts with Flanges

05 102 Butts with Flanges

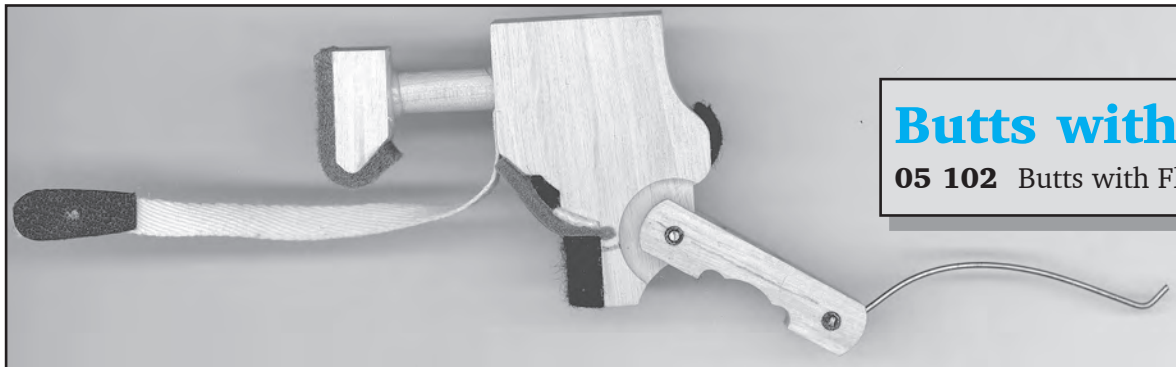

Steinway Style Upright Parts

Steinway Uprights Parts

Damper Blocks Set

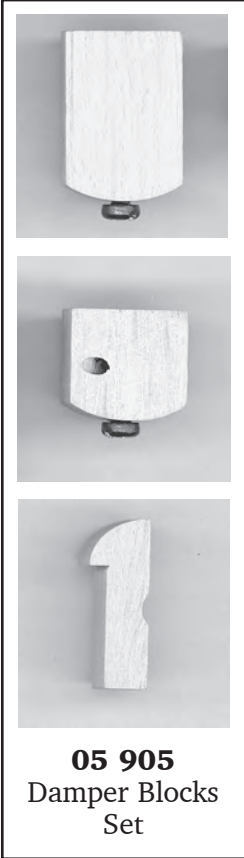

Recommended
Round Type
Damper
Blocks
with felt heads
see pages 16,18

Double Butt Flanges Only

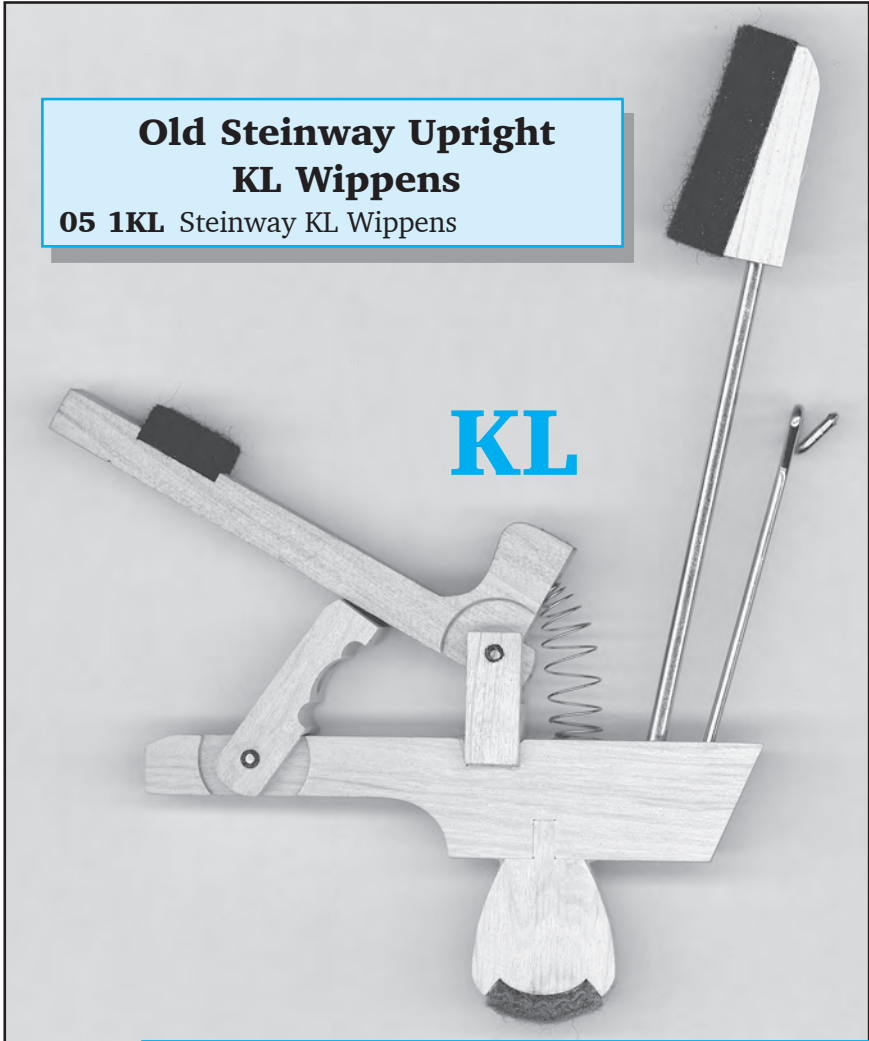
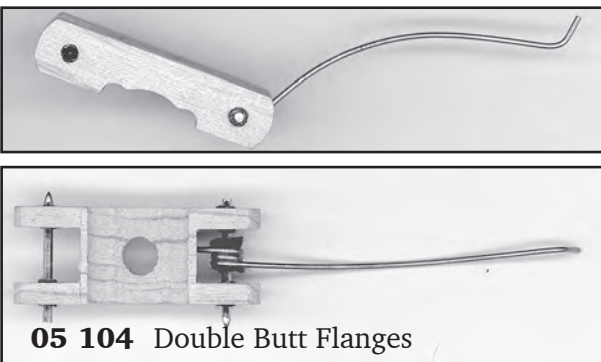

Old Steinway Upright KS Wippens
05 1KS Steinway KS Wippen



BUTT PLATES

61 519A Butt Plates (With Screws)

REPAIR DAMPER SPRINGS



To replace a broken damper spring, hook the spring around the damper flange screw. Saves having to replace the cord.

61 538A Repair Damper Spring

UPRIGHT HAMMER SPRINGS

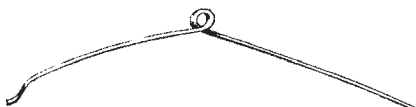

61 545 Upright Hammer Springs 100

REPAIR HAMMER SPRINGS



Can be installed in any full size action without removing spring rail. Come with screws.

61 538B Repair Hammer Springs

UPRIGHT JACK SPRINGS



61 531 Upright Jack Springs Pkg. 100

RUBBER GROMMETS

61 605 Round Rubber Grommets. Pkg. 90

61 605A Square Rubber Grommets Pkg. 90



PLASTIC SNAP-ON ELBOWS

Replaces old Plastic.
Vagias Snap-on Elbows
can be installed without
removing the action.

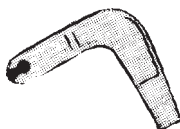

61 631V Plastic Snap-on Elbows 90° Set

Many Items are Discontinued. Looking for a Tool You Don't See? Call and Ask Us - Limited Stock May Still Be Available On Discontinued Items.

LARGE PLATE SCREWDRIVER



Heavy duty screwdriver with square shank-end to fit tuning hammer. Large plate screws tightened with ease.

10 12M Plate Screwdriver @

PHILLIPS PLATE SCREWDRIVER



Heavy duty Phillips screwdriver with square shank-end to fit tuning hammer. For Asian pianos with Phillips head plate screws.

10 12MP Phillips Plate Screwdriver @

KEY RAIL EASERS



Fit the combination handle (13 30).

10 17MC Balance Rail Easer@

MINI TUNING HAMMER



A tuning hammer with adjustable shaft that fits in your pocket. Works well in treble section in grand tuning.... No need to raise the lid!

10 5ML Mini Tuning Hammer @

Professional Key Rebushing

Complete Job

For Grands:

- Send in the Keys on the Frame.
- We will Rebush, clean the Frame and the ins.
- No easing will be necessary!
- **We guarantee a perfect fit!**

For Uprights:

- Give us the diameter of the Front and Balance Pins. Since we do not have the Key Frame - some fitting may be required.

Call for details - 818-700-2100

EXTENSION TUNING HAMMER

Rubberex handle, stainless steel rod and extension assembly. Length 12", Extends 6 1/2" Comes with Medium Head, 12 2T2 Tip, Carrying Case and Tip Wrench.



12 2S Extension Tuning Hammer @
(RubberexHandle)



12 2SR Rosewood Handle Ext. Hammer @

NON-EXTENDING TUNING HAMMER

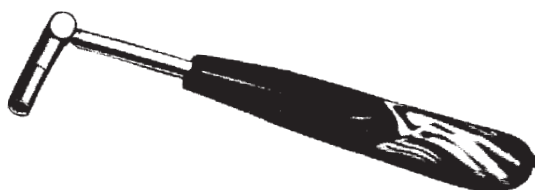

Rubberex handle length is 8 1/4", overall length 12". Comes with 2T2 Tip, 2H2 Head

12 2P Non-Extending Tuning Hammer... @
12 2ST Shaft only for 12 2S & 12 2SR... @

Tuning Heads

- 12 2H1** Tuning Head Short 7/8" @
- 12 2H2** Tuning Head Med. 1 1/2" @
- 12 2H3** Tuning Head Long 3".....@
- 12 2H5** Tuning Head Extra Long 5" @

Star Tips for Tuning Heads

- 12 2T1** Star Tip Small #1 @
- 12 2T2** Star Tip Medium #2 @
- 12 2T3** Star Tip Large #3 @

FAX US YOUR ORDER (818) 700-2104

GOOSENECK TUNING HAMMER



Wooden handle, one-piece shaft, std. #2 Tip.
12 3 Gooseneck Tuning Hammer @

BASIC TUNING KIT

Comes with 12 3 Gooseneck Tuning Hammer, Assorted Mutes, Felt Temperature Strip, and Tuning Fork.

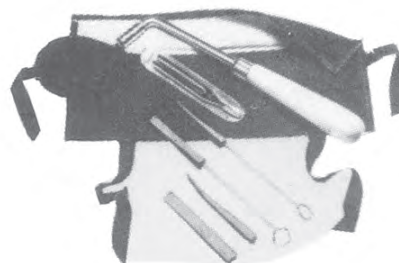

Includes Canvas Carrying Case.

12 91B Basic Tuning Kit @

RATCHET HEAD

Star Tip #2 on one end, 3/8" Square Ratchet Drive on the other, for removal of old pins.



12 6R Ratchet Head @

POWER PIN SOCKET

Triangular Shank end fits 1/2" Chuck on Reversing Power Drill. Remove all old tuning pins fast when restringing.



12 6S Power Tuning Pin Socket @

TIP WRENCH



For changing Star Tips on Tuning Hammers.
12 8 Tip Wrench @

RUBBER TUNING MUTES

- 12 20B** 3" Long X 3/4" Wide @
- 12 21A** 4" Long X 1/4" Wide @
- 12 21B** 4" Long X 1/2" Wide @
- 12 22B** 6" Long X 1/2" Wide @



12 20H 3" Long X 3/8" Wide @
(With Wire Handle)

**Before You Dial The Phone... 818-700-2100
Do You Have Your Part Numbers?**

SPLIT MUTE

Blue Steel Handle. Split rubber mute.

12 23 Split Mute @

PAPPS MUTE



A treble mute of tweezer design. Imported from England. 8" Long, with Case.

12 23A Papps Mute @

STICK MUTE



05 20T Stick Mute. High Quality @

TEMPERAMENT FELTS

12 24A Temperament Strip Muting Felt.. @

12 24AT Thin Temp. Strip Muting Felt... @

SHEFFIELD TUNING FORKS

From England, these forks have long sustain. A-440 or C-523.3. Blued Steel. Plastic Case.

12 53A Tuning Fork "A-440" @

12 53C Tuning Fork "C-523.3" @

Regulating Tools, Blades & Screwdrivers

COMBINATION HANDLE



This standard black handle accomodates many different blades and tools. The tools are secured and released in locking collett.

13 30 Combination Handle @



13 31 Bent Backcheck Regulator @

VERTICAL SPOON BENDER



Round Head Spoon Bender for Combo Handle.

13 32C Vertical Spoon Bender @

7" REGULATING SCREWDRIVER



For Vertical Let-Off Adjustment.

13 33A 7" Regulating Screwdriver @

DAMPER REGULATOR



Insert between shanks to grab Vertical Damper Wires.

13 34A1 Damper Regulator @

DROP SCREW REGULATOR 5"



Regulates small spade head Grand Drop screws.

13 35A Drop Screw Regulator 5" @

OFFSET KEY SPACER



Adapted to reach between front row of key pins, making sharps easier to space. Used for Spacing and Squaring Grand or Vertical Keys.

13 37A Offset Key Spacer @

HAMMER SHANK REDUCER

Used to remove glue and size Vertical and Grand Hammer Shanks.



13 38 Hammer shank Reducer @

PHILLIPS SCREWDRIVER 8"

Large Phillips Screwdriver. 1/4" Shank. 8" Lng.

13 40P8 Phillips Screwdriver 8" @

MEDIUM PIANO SCREWDRIVER

Flat Screwdriver. 3/16" Shank. 8" Length.

13 41A Medium Piano Screwdriver @

ACTION FLANGE SCREWDRIVER



Made to reach vertical Flange Screws.

13 41F Action Flange Screwdiver @

KIMBALL SCREWDRIVER



Thin Blade reaches Kimball Brass Rail Screws.

13 41K Kimball Screwdriver @

13 42A Screwholding Screwdriver @

Online ordering...

www.pacificpiano.com

CAPSTAN WRENCHES



13 45 Universal Capstan Wrench

13 45A Pointed End Capstan Wrench



13 47A Steinway Capstan Wrench

“HART SPRING TOOL”



13 48 Hart Spring Tool

13 48H6 6" Spring Hook

8" TWEEZERS



13 49A 8" Tweezers

13 49L Punching Lifter

GRAND IN-PIANO LET-OFF REGULATING TOOL



13 77 Grand In-Piano Let-Off Regulating Tool

SMALL CANVAS TOOL ROLL

11" Long X 8 1/2" Wide. All Small Pockets. Ideal for regulating tools. (Empty, No Tools)

13 76S Small Canvas Tool Roll

LARGE CANVAS TOOL ROLL



26" Long X 13 1/4" Wide. Tools are held in pockets. Brown Canvas with Fleece Lining. (Empty, No Tools)

13 76L Large Canvas Tool Roll

REGULATING KIT

Contains Combination Handle with Eight Basic Tools. Brown Canvas Case.



13 91R Regulating Kit

KEY DIP BLOCK (3/8")

Key leveling and Touch Dip.



13 72 Key Dip Block (3/8")

TOKIWA KEY DIP BLOCK SET

NEW ITEM!

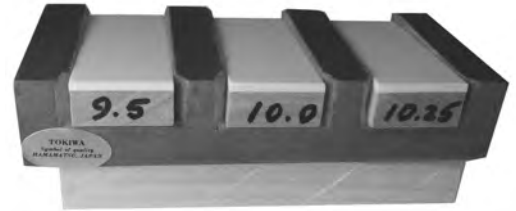

05 72T Tokiwa Key Dip Block Set. Set of (three thicknesses) 9.5 mm, 10.0 mm, 10.25 mm. Comes in custom fit holder.

GRAM WEIGHTS

For measuring Touch-weight (grams) in all keyboards.



13 72G Gram Weights

SOUNDBOARD CLEANER

3/4" blade with 22" handle for reaching under the bass strings and through plate holes.



13 82S Soundboard Cleaner

13 82 Soundboard Steel

GRAND KEY LEVELING LEADS

Used to level the grand keys after the action is removed. Simply slide the brass hook over back check. No ugly holes are punched in keys, and it will not interfere with damper levers if keys are to be leveled in piano. Spring brass hook moded into properly weighted lead.



13 10 Grand Key Leveling Leads

(Set of 52 ea)

ACTION CRADLE

All metal, fully adjustable, accommodates all types of upright, spinet, and console actions. Action is free to rotate to any desired position, and can be locked in any position. Includes Sled Runners, *not shown*.

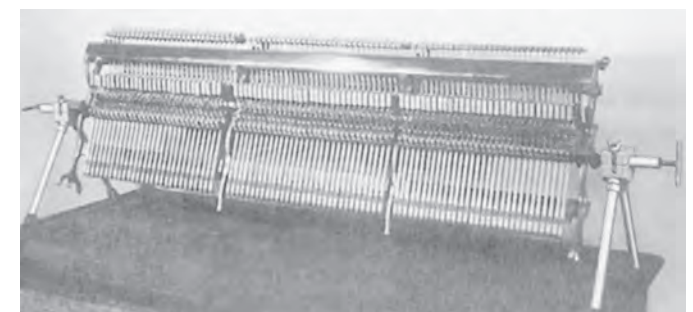

13 99K Action Cradle

CENTER PINS

- 14 389** Center Pins 1 oz. Package
- 14 389-18** Center Pins .046
- 14 389-185** Center Pins .047
- 14 389-19** Center Pins .048
- 14 389-195** Center Pins .049
- 14 389-20** Center Pins .050
- 14 389-205** Center Pins .051
- 14 389-21** Center Pins .052
- 14 389-215** Center Pins .053
- 14 389-22** Center Pins .054
- 14 389-225** Center Pins .055
- 14 389-23** Center Pins .056
- 14 389-235** Center Pins .057
- 14 389-24** Center Pins .059
- 14 389-25** Center Pins .063

CENTER PIN HOLDER

Center Pin Holder comes filled.



- 14 54H** Center Pin Holder

STARRETT PIN VISE



Hole bored thru the handle. Collett adjusts from .050 to .125, to hold center pins and Burnisher, Rat Tail File, or Reamer. 3 1/4" Overall Length.

- 14 56** Starrett Pin Vise

TAPERED BURNISHER



For Sizing the Felt Bushing (Blade Only).

- 14 57** Tapered Burnisher

RAT TAIL FILE



For Removing Felt from Bushing (Blade Only).

- 14 58** Rat Tail File

TAPERED REAMER



For Reaming Birdseye in Flanges (Blade Only).

- 14 59** Tapered Reamer

WOODEN HANDLE ONLY

- 14 60** Wooden Handle Only

**Before You Dial The Phone...
Do You Have Your Part Numbers?**

REPINNING TOOL

Easy to use. Center pins are quickly replaced with this convenient tool. Pays for itself in time saved on your first few jobs.



- 14 43A** Repinning Tool

CENTER PIN PLIERS

Parallel Action to remove center pins without tearing a bushing. Adjustable pin travel. The tool for removing Plastic Elbows from Spinnet pianos with drop actions. Coil Spring Pliers 6 1/4" Long.



- 14 43P** Center Pin Pliers

FLANGE BUSHING BROACH KIT

Comes in canvas tool pouch with 8 broaches, sizes graduate from .048 thru .055.



- 14 61P** Flange Bushing Broach Kit

FLUSH CUT PIN NIPPERS

Flush side cutters for Center Pins. Leaves a Smooth, Flat Cut. These work!



- 14 2111X** Flush Cut Pin nippers

ROSLAU IMPORTED WIRE WITH BRAKES

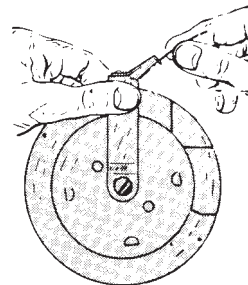

- 16 202-** 1/3 lb. Spools, (Sizes 12-22)

16 202-12 .029	16 202-175 .040
16 202-125 .030	16 202-18 .041
16 202-13 .031	16 202-185 .042
16 202-135 .032	16 202-19 .043
16 202-14 .033	16 202-195 .044
16 202-145 .034	16 202-20 .045
16 202-15 .035	16 202-205 .046
16 202-155 .036	16 202-21 .047
16 202-16 .037	16 202-22 .049
16 202-165 .038	
16 202-17 .039	

WIRE CANISTER (1 lb)

Canister for 1lb. Coils. Unscrews into two halves for loading. Wire dispenses easily thru large center hole.



16 206C Wire Canister (1 lb.)

ROSLAU IMPORTED PIANO WIRE

16 206 1 lb. Coils, Spooled,

16 206-12	Polished 1lb .029
16 206-125	Polished 1lb .030
16 206-13	Polished 1lb .031
16 206-135	Polished 1lb .032
16 206-14	Polished 1lb .033
16 206-145	Polished 1lb .034
16 206-15	Polished 1lb .035
16 206-155	Polished 1lb .036
16 206-16	Polished 1lb .037
16 206-165	Polished 1lb .038
16 206-17	Polished 1lb .039
16 206-175	Polished 1lb .040
16 206-18	Polished 1lb .041
16 206-185	Polished 1lb .042
16 206-19	Polished 1lb .043
16 206-195	Polished 1lb .044
16 206-20	Polished 1lb .045
16 206-205	Polished 1lb .046
16 206-21	Polished 1lb .047
16 206-22	Polished 1lb .049

**Quality Nippon / Denro
Tuning Pins**

PIANO TUNING PINS - BLUE

Highest quality, cut thread pins.

17 303B-2/0	Length, 2 3/8"
17 303B-2/4	Length, 2 1/4"
17 303B-2/2	Length, 2 1/2"
Dia. .282	Set 250
17 303B-3/0	Length, 2 3/8"
17 303B-3/2	Length, 2 1/2"
Dia. .286	Set 250
17 303B-4/0	Length, 2 3/8"
17 303B-4/2	Length, 2 1/2"
Dia. .291	Set 250
17 303B-5/0	Length, 2 3/8"
Dia. .296	Set 250

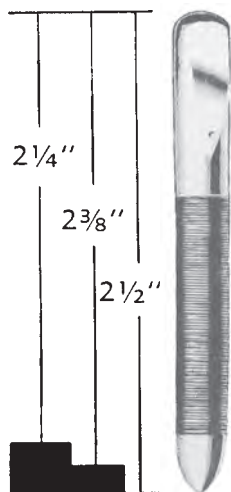

TUNING PINS - NICKEL

Thread Blued on all Nickel Pins.

17 303N-2/0	Length, 2 3/8"
17 303N-2/4	Length, 2 1/4"
17 303N-2/2	Length, 2 1/2"
Dia. .282	Set 250
17 303N-3/0	Length, 2 3/8"
17 303N-3/2	Length, 2 1/2"
Dia. .286	Set 250
17 303N-4/0	Length, 2 3/8"
17 303N-4/2	Length, 2 1/2"
Dia. .291	Set 250
17 303N-5/0	Length, 2 3/8"
Dia. .296	Set 250

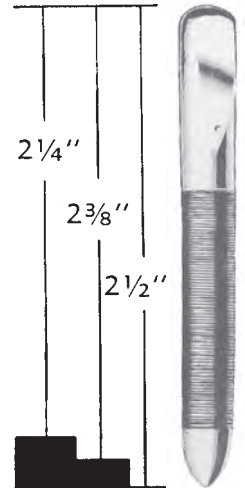

TUNING PIN TIGHTENER

17 247Q "Instant Pin Tight" Tuning Pin Tightener

PINBLOCK MATERIAL

Cross Laminated Maple, 1/8" Ply. Panel 60" X 9"

17 66W1	Thickness 1 1/4"
17 66W2	Thickness 1 3/8"
17 66W3	Thickness 1 1/2"

PINBLOCK SUPPORT JACK

Made By Starrett. Sold by each; one jack, two sleeves.



17 66 Pinblock Support Jack

DELUXE PINBLOCK SUPPORT

For supporting grand pinblocks while tuning pins are driven in. 11" x 4", top and bottom are made of laminated maple. Easy height adjustment made by simply turning wing nuts by hand.



17 66D Deluxe Pinblock Support.

MAPLE WOOD PLATE BUSHINGS

Eyehole may need reaming when using oversize pins. Sets of 250.

17 256A	1/4" High 250
17 256B	5/16" High 250
17 256C	3/8" High 250
17 256Y	Yamaha and Kawai Type, 5/16" High (smaller diameter) 250



PLATE BUSHING PUNCH



17 257P Plate Bushing punch

SOUNDBOARD SHIMS

Selected White Sitka Spruce. 27/64" Thick, 30" Long, 3/16" Wide. Tapers to nothing.

17 253 Soundboard Shims@

SHIMMING KNIFE



MADE IN GERMANY

11" long with hardwood handle

17 87G High quality Shimming Knife....

GRAND AGRAFFES

Solid Brass, Threaded Shank.

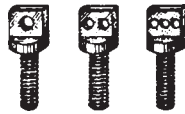

Diameter .211

17 390A-1 Single Hole 7/32"

17 390A-2 Double Hole 7/32"

17 390A-3 Triple Hole 7/32"

Diameter .250

17 390B-1 Single Hole 1/4"

17 390B-2 Double Hole 1/4"

17 390B-3 Triple Hole 1/4"

AGRAFFE WRENCH

Heavy duty steel T-wrench for turning grand agraffes.



17 390W Agraffe Wrench

SCARLET STRINGING BRAID



5/8" Width, in rolls. Thin Cotton Tape. For muting strings between bridge and hitch pins.

17 182A Scarlet Stringing Braid

STARRETT MUSIC WIRE GAUGE.

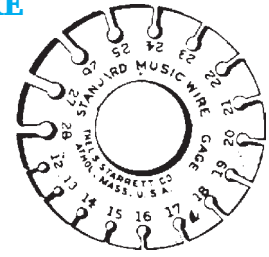

Sizes #12 to #28

17 79 Starrett Music Wire Gauge

STARRETT MICROMETERS

Precision Made in U.S.A. The most accurate way to measure Music Wire, Center Pins, Punchings, Felts, or Screws.

17 436P Starrett Micrometer

17 436D Starrett Micrometer (Digital Read Out)

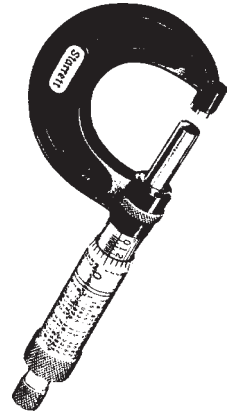
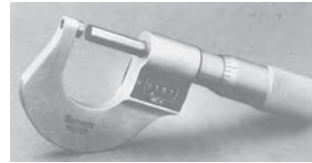

IMPACT COIL LIFTER & SETTER



Efficient tool for making neat coils on tuning pin. Case Hardened Tip fits under or over the coil. Sliding Counter-Weight slides up and down on shaft to "tap" the windings up or down. Replacement tips are sold separately.

17 11K Impact Coil Lifter & Setter

17 11KT Tip only for Lifter/Setter.....

POLITA STEEL POLISH CAKE

Rubber block impregnated with emery. Excellent for removing rust and corrosion from strings, pedals, etc.



17 251 Polita Steel Polish Cake.....

TUNING PIN PUNCH



For driving new tuning pins. Hardened Steel. 5/8" X 4 3/8".

17 14 Tuning Pin Punch.....

FAX US YOUR ORDER (818) 700-2104

WIRE CUTTERS

Cuts all piano wire.



17 1528 Wire Cutters ... Best Quality - German Made.

TUNING PIN GAUGE.

Measure pins while still in the piano.
Sizes 2/0 thru 6/0.



17 54T Tuning Pin Gauge

STRING LIFTER AND SPACER



17 64 String Lifter and Spacer

STRING HOOK

Very sharp point for getting into "tight" spots.



17 64H String Hook

TUNING PIN CRANK

This tool is used to make coils when installing new pins. A "must" for restringing.

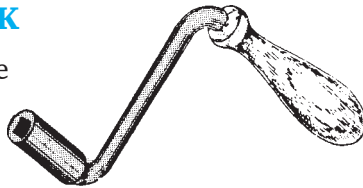

17 65 Tuning Pin Crank

CUSTOM BASS STRINGS

26 SNG Custom Bass String, Single Wound

26 DBL Custom Bass String, Double Wound

26 BASTS ea.

Custom Bass Strings by Set - Customer must provide paper pattern and First & Last String of each section.

FAX US YOUR ORDER (818) 700-2104

UNIVERSAL REPLACEMENT BASS STRINGS

The Schaff Universal Bass String Packet enables "on the spot" replacement of single wound bass strings, except in the largest Grands.

Immediate replacement of broken or dead strings on the job saves a return trip, and time required to make a custom string.

Hexagonal Steel Core allows unwinding the Copper Wrap to fit a variety of Pianos.

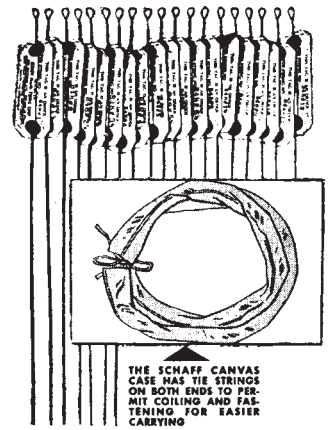

PACKETS OF ASSORTED STRINGS

- 26 204-19** Set of 19 ea B48 Series
- 26 204-37** Set of 37 ea S50 Series
- 26 205-10** Set of 10 ea S50 Series (Heavy)
- 26 205-6** Set of 6 ea B48 Series (Very Heavy)

INDIVIDUAL UNIVERSAL BASS STRINGS



All B48 Sizes: -1 thru -12 @			
26 B48-1	.144"	26 B48-7	.075"
26 B48-15	.134"	26 B48-75	.074"
26 B48-2	.128"	26 B48-8	.069"
26 B48-25	.124"	26 B48-85	.067"
26 B48-3	.117"	26 B48-9	.063"
26 B48-35	.112"	26 B48-95	.061"
26 B48-4	.109"	26 B48-10	.059"
26 B48-45	.102"	26 B48-105	.056"
26 B48-5	.097"	26 B48-11	.054"
26 B48-55	.088"	26 B48-12	.051"
26 B48-6	.084"		
26 B48-65	.077"		
All B48 Sizes -01 thru -06 . @			
26 B48-01	.155"	26 B48-04	.175"
26 B48-02	.158"	26 B48-05	.186"
26 B48-03	.165"	26 B48-06	.194"

Individual S50 Strings are discontinued.

**Before You Dial The Phone.... 818-700-2100
Do You Have Your Part Numbers?**

SHANK KNURLING PLIERS



For knurling or compressing hammer shanks. Also useful for squeezing the shoulder of very hard hammers. Great all purpose Pliers.

29 2128 Shank Knurling Pliers

ROUND NOSE PLIERS

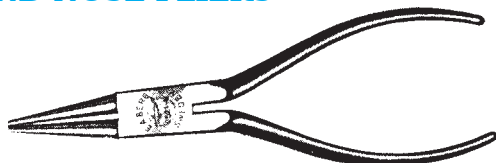

Make Loops, or form wire for Splicing Strings.

29 2521 Round Nose Pliers

KEY EASING PLIERS



29 52K Key Easing Pliers

REGULATING PLIERS

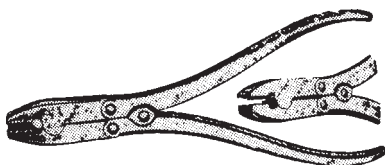

7½" Long. For bending Backcheck and Bridle Wires.

29 52R Regulating Pliers

TAPERED REAMER

Tapered Reamer for reaming Grand Hammer Heads to fit Shanks. Essential tool for grand hammer replacement. Fits tap handle.

31 18 Tapered Reamer

CHECKERING FILE

Imported File cuts horizontal grooves in Grand Hammer Tails. Gives a Factory look to hammers, and higher, more positive checking.



31 18CH Checkering File

ELECTRIC HAMMER IRON

Continuous Heat, Must be unplugged when at working temperature. Ironing Hammers makes a Brighter Tone, and improves appearance of hammers after filing.



A "must" tool for the serious hammer voicer.

31 68E Electric Hammer Iron

SANDPAPER FILE



Sandpaper File for Shaping new and old hammers.

31 78 Sandpaper File

"HART" SINGLE NEEDLE VOICING TOOL



31 73H "Hart" Single Needle Voicing Tool with allen wrench

ADJUSTABLE FELT PICKER



Black Plastic Handle. Comes curved, straight, or adjustable.

31 73A Adjustable Felt Picker

COMBO-HANDLE FELT PICKER

Adjustable Voicing Tool fits 13 30 Combination handle.



31 73D Combo-Handle Felt Picker

31 73N Needles only

GRAND SHANK PRESS

Removes Grand Hammers from Shanks.



31 75S Grand Shank Press

UPRIGHT HAMMER AND BUTT EXTRACTOR.

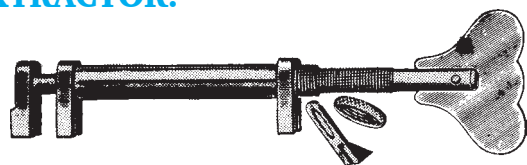

This tool is used to remove hammer heads. Foot presses against Butt, Head has beveled plate for extracting angled hammers. Shank Clamp can be used as a spacer, or to pull a shank broken off from the butt, clamp provides base. Upright or Spinnet

- 31 93A** Hammer & Butt Extractor
- 31 93B** Clamp

UPRIGHT PEDALS (Sets of Three)

38 330A Brass Upright Pedals
 Brass Toe Cap. Right and Left Pedal 8-1/2" Overall. Center Pedal 9" Overall. Pin to Horn: Right and Left 5" Center 5-3/8"



38 330B Brass Upright Pedals
 Brass Round Toe. All Pedals 8-1/4" Overall Length. Pin to Horn: All Pedals 4-7/8"



38 331B Nickel Plated Upright Pedals
 Round Toe. Right and Left pedal 9-1/2" overall. Center Pedal 9-7/8" overall. Has hole for pin in center of middle pedal.



GRAND PEDALS (Sets of Three)

Solid Brass, No Horn, Length 8-3/4". Pin to Center of Rod Hole 3-7/16".



- 38 340S** Brass Grand Pedals

PEDAL PINS



Standard Pedal Pin. Center Splines for Press Fit.

- 38 315P** Pedal Pins

FAX US YOUR ORDER (818) 700-2104

PEDAL BRACKETS

Steel Brackets with Nylon Pin Bearing. Sold by the Set of 6.



- 57 322** Pedal BracketsSet

BRASS PEDAL RODS



ADJUSTABLE GRAND PEDAL RODS. For Steinway and others. Knurled lock nut. 1/4" diameter rod. (shown on left). Set of 3.

- 38 339A** Brass Pedal Rods, 1/4" diameter(Adjustable) ...set

ADJUSTABLE GRAND PEDAL RODS. Brass, 3/8" diameter rod. (shown on right). Set of 3.

- 38 339B** Brass Pedal Rods, 3/8" diameter rod (Adjustable). Set



GRAND LEG PLATES

Replaces locking leg plate on Grands. Male and Female Cast Iron, Four Screw Holes. Sold by Pair, or Set of Three Pair.



- 42 368** Grand Leg Plates

PLASTIC CASTER CUPS

5-1/8" Overall Diameter made from cast plastic, available in Black, Walnut, Ivory, or clear. Sold Individually.



- 42 670B5** Black Caster Cups
- 42 670I5** Ivory Caster Cups
- 42 670W5** Walnut Caster Cups
- 42 670C** Clear Caster Cups

WOOD CASTER CUPS

42 671 Wood Caster Cups. 3-5/8" diameter with felt backing in Ebony, Walnut and Mahogany



UPRIGHT CASTERS

Cast Iron 4-Hole Socket is fastened to Stem as in most older uprights.

1 3/4" Steel Wheel, Socket Diameter 2 1/2". Sold By Each.



- 42 370A** Upright Casters

DOUBLE WHEEL RUBBER CASTERS

For Grands or Uprights. When replacing original steel casters on uprights, (except 42 370a), Round Sockets and Wood Dowels are needed to install. On Grands, if the stem does not fit, Square sockets are available.

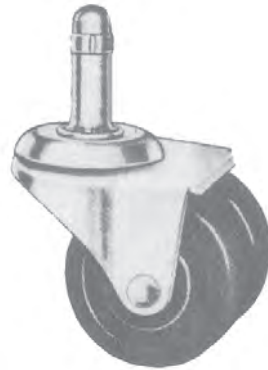

Sold by the Each.

42 X373 Faultless Double Wheel Rubber Caster.....

42 X8016 Round Socket 2 1/8" Dia. ...



42 X8015 Square Socket 1 1/2" Sq.



42 X374 Wood Dowels



BRASS SPINET CASTERS

Fit Front Legs on Spinets. Small Furniture Socket with 1" Toothed Track Plate also available for installation. 1-1/4" Wheel in Brass Plated, or Solid Brass. Sold By the Each.



42 G645 Solid Brass Small Spinet Caster....

42 G645B Brass Plated Sm. Spinet Caster..

42 G548 Furniture Socket

42 X8012 Small Steel Casters 1-3/8" Steel Wheel. Fits X8015 Square Socket.

GRAND BRASS CASTERS

All Grand casters fit x8015 Square Socket.

Solid Brass Grand Casters, 1-3/4" Wheel.



42 X377C Solid Brass

42 X377B Small (Brass Plated) Small Grand Casters, 1-3/8" Wheel.

GRAND PIANO STAGE DOLLY



Used in auditoriums, schools and churches everywhere, our Grand Stage Trucks are the SAFE way to provide Mobility for even the largest Grand Pianos. Heavy Steel Construction, to ensure that truck will not bow. Adjustable Arms allow Three Sizes of Truck to fit all types of Grands. All Trucks have 5" Steel Wheel with Rubber Tire, Ball Bearing Swivel for Smooth Rolling. Packed in 3 cartons for UPS Shipment. Black Finish Only.

TO ORDER: Measure Overall Length of Piano when selecting Size. On Large Grands, (Over 7'), please check diameter of leg above the caster. Two size Leg Cups are available, Standard Cup 3-1/2", Large Cup 4-1/2". Please Specify if you need Large Cups.

45 6542 Grand Truck (4'-8" to 5'-11") ...

45 6543 Grand Truck (6" to 7'-6") ...

45 6544 Grand Truck (8' to 9')

GRAND LEG DOLLIES

Use these for the Grand that is moved OCCASIONALLY. Made from Cast Iron Cups (Dark Brown Color), with Three Rubber Tires on each cup. Standard Stem in center of cup slips into most grand sockets when original caster is removed. Pedals & Keyboard original height.



45 378H Grand Leg DolliesSet 3

SPINET TRUCK

Designed to support front legs that go all the way to the floor on most Spinets. Adjustable Length & Width. Frame construction takes strain away from legs, and allows one person to roll the piano. Rubber Wheels with Ball Bearing Swivel. Black Finish.



45 6545 Spinet Truck

TWIN DOLLIES

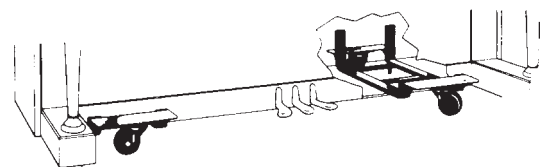

Excellent for most vertical Pianos. Not for Spinets. Ball Bearing Swivel, 2 1/2" Rubber Wheels. Black Finish. Sold by Set of Two.

45 6560 Twin DolliesPair

Many Items are Discontinued. Looking for a Tool You Don't See? Call and Ask Us - Limited Stock May Still Be Available On Discontinued Items.

HEAVY DUTY TWIN DOLLIES



This Pair of Steel Trucks works best on larger Studio Pianos Without Front Legs. Will Fit any Vertical Piano with a bottom panel width of 15" or Less. Screws to back posts for secure mounting. 5" Rubber Tire with Steel Rim, Ball Bearing Swivel. Wider Wheelbase is a function of Large Tires, for smooth and safe rolling of verticals. Bronze Finish. Set of Two.

45 6561 Heavy Duty Twin Dollies ..Pair

**PIANO FELTS & PUNCHINGS
FRONT RAIL WOVEN FELT PUNCHINGS**

Green Woven Felt. High Quality, 5/8" Diameter, Uniform Thickness. Send a sample if you are not sure of the thickness (Six Sizes Available). Sold Per 100.

- 48 101** Thin Front Rail Felt Punchings
- 48 102** Med. Thin Front Rail Punchings
- 48 103** Med. Front Rail Felt Punchings
- 48 104** Med. Thick Front Rail Punchings
- 48 105** Thick Front Rail Felt Punchings
- 48 106** Steinway 7/8" Diameter

FRONT RAIL PAPER PUNCHINGS

13/16" Diameter. Sold per 1000

- 48 121** (.005) Thin Paper
- 48 122** (.010) Thick Paper
- 48 123** (.018) Thin Card
- 48 124** (.034) Medium Card
- 48 125** (.044) Thick Card
- 48 126** (.054) Extra Thick Card

BALANCE RAIL FELT PUNCHINGS

Woven White Felt. 1/2" Dia., High Quality, Uniform Thickness. Send a sample if you are not sure of the thickness (Five Sizes Available). Sold Per 100

- 48 110** Thin Bal. Rail Felt Punchings
- 48 111** Med. Thin Bal. Rail Punchings
- 48 112** Med. Bal. Rail Felt Punchings
- 48 113** Med. Thick Bal. Rail Punchings
- 48 114** Thick Bal. Rail Felt Punchings

BALANCE RAIL PAPER PUNCHINGS

1/2" Diameter. Sold Per 1000

- 48 131** (.003) Thinnest Paper
- 48 132** (.005) Thin Paper
- 48 133** (.007) Thin Paper
- 48 134** (.010) Medium Paper
- 48 135** (.015) Medium Paper
- 48 136** (.020) Thick Paper
- 48 137** (.034) Thin Card
- 48 138** (.044) Medium Card

BACK RAIL CLOTH

Green Woven Cloth. 1 1/2" W. x 52" L. Per Strip

- 48 140** Thin Backrail Cloth
- 48 141** Medium Thin Backrail Cloth
- 48 142** Medium Backrail Cloth
- 48 143** Medium Thick Backrail Cloth
- 48 144** Thick Backrail Cloth
- 48 145** Steinway Cut (2 3/4" Wide)

KEY BUSHING CLOTH

Scarlet, Pre-stripped for Correct Width of Key Bushing, or sold per inch from 52" wide bolt. This Durable Cloth has a variety of applications. Besides Keys, Bushing Cloth is used in Pedals, as Understring Felt, Music Rack Slides, etc. Our Cloth is the finest White Core. Shrink Resistant, will swell with moisture only .05%. Dense Weave for long wear. Two Thicknesses.

Pre Stripped 3/8" Wide X 54" Long. Three Strips required to bush one set of keys both balance and front rails.

- 48 147S** THIN Stripped Key Bushing Cloth
..... Strip
- 48 148S** MEDIUM Stripped Key Bushing Cloth
..... Strip
- 48 148BS** BULK Key Bushing Cloth Inch
Sold per Inch X 52". This Cloth Tears in Straight Strips. Deep Scarlet Color, White woven Core. Also used as Understring Cloth.

FLANGE BUSHING CLOTH

Correct Thickness for Re-Bushing Wood Flanges. Width 17/64" X 18" Long. Sold per Strip or Dozen Strips

- 48 150** Flange Bushing ClothStrip

NAMEBOARD FELT

Nameboard Felt. 5/8" W. x 52" L. Strips. Scarlet or Maroon. Sold by the Strip or Dozen Strips



- 48 152M** Maroon Nameboard Felt ...Strip
- 48 152S** Scarlet Nameboard FeltStrip

HITCH PIN PUNCHINGS

Punched from Thin Scarlet Bushing Cloth, Comes in Two Diameters, 1/2" and 3/8". Used on Plate Pins when restringing. Sold by set 100 ea.

- 48 155A1** Hitch Pin Punchings 3/8" .
- 48 155A2** Hitch Pin Punchings 1/2"

REGULATING BUTTON PUNCHINGS

Punched from Medium or Thick Action Cloth, (Woven Felt). Used on Let-Off Buttons in all Pianos.

- 48 155C** Regulating Punchings (Med.) 100
- 48 155D** Regulating Punchings (Thick) 100
- 48 158** Steinway Style Key-end Felt

HAMMER BUTT FELT

Pre-Cut Squares, or
52" Strip. Red Color.



- 48 156A Hammer Butt Felt Squares ...100
- 48 156B Hammer Butt Felt Strip100

GRAND UNDERSTRING FELT

Red, 1/2" or 1" Wide. 52" X 1/4" Thick Strips.

- 48 159A Grand Understring Felt 1" Strip
- 48 159C Grand Understring Felt 1/2" Strip
- 48 159D Dense Understring Felt 1" W/36" L....
- 48 159B 2" Wide x 52" Long

Also see 48 148BS Bulk Bushing Cloth

SPRING RAIL FELT

Red Pressed Felt, 13/16" Wide. Sold by 52" Long Strips.

- 48 160 Spring Rail FeltStrip

UPRIGHT HAMMER RAIL CLOTH

Soft Woven Green Felt. 52" Strips

- 48 162 Upright Hammer Rail Cloth Strip

MUFFLER RAIL FELT

- 48 163T Tapered Thickness Muffler Strip

ACTION CLOTH

Fine Quality Woven Felt. Used where capstans contact wippens. 3 Thickness.



- 48 165 Thin Action Cloth (White) Strip
- 48 166 Medium Action Cloth (Green) Strip
- 48 167 Thick Action Cloth (Gold) Strip

GRAND HAMMER REST FELT

Thick, 52" Strip.

- 48 178A Grand Hammer Rest Felt Strip

GRAND DAMPER FELT (COMPLETE SET)

05 189T Pre-cut High Quality Felt. Set
See Tokiwa Damper Felt pages 7 & 19...

GRAND DAMPER FELT (STRIPS)

Sold in 27" Strips. With or without Red Backing. Single, Double, or Trichord Cut.

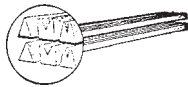

UPRIGHT BASS DAMPER FELT

WEDGE BLOCKS - Sets of 10 Sgl, 20 Dbl. Also Sold By Dozen each type. Two Lengths, 1-3/8" (Spinet), 1-3/4" (Upright).

By the Set (10 single 20 Double)

- 48 190A Bass Damper 1-3/8"
- 48 190B Bass Damper 1-3/4"



SINGLE

By the Dozen (Spinet)

- 48 190CS Single 1-3/8"
- 48 190CD Double 1-3/8"



DOUBLE

- 48 190CT Trichord 1-3/8" continued next column

- By the Dozen (Upright)
- 48 190DS Single 1-3/4"
- 48 190DD Double 1-3/4"
- 48 190DT Trichord 1-3/4"



TRICHORD

FLAT UPRIGHT DAMPER FELT

Flat Creased, Red Back. Tapered cut.
By Tokiwa. Sold per Set.



- 05 185BL Tokiwa Upright Treble Damper Felt

FELT CUTTER

Adjusts to Width of strip, and Length of cut piece. Uses standard single edge razor blade.

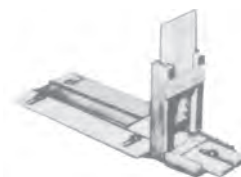

- 48 67C Felt Cutter

HINGES, LOCKS, & HARDWARE

Hinges are sold in Pairs. Solid Brass unless otherwise specified. Screws not included.

- 54 343B Small Hinge, Music Rack or Prop Stick. 1-3/4" x 1" ... Pair



- 54 345 Grand Lid Hinge Large 5-7/8" x 2"Pair
- 54 347 Grand Lid Hinge Medium 5-3/8" x 1 3/4", Pair

- 54 349A Square Bent Butt Hinge 5-3/8" x 1 3/4", 7/8" to bend, 90° bent piece 1"Pair

- 54 349A1 Grand Lid Hinge, Bent Butt. Large: 5 1/2" x 2", 7/8" to bend, 90° bent piece 1 3/4" Pair



CONTINUOUS HINGE



Solid Brass. 1" Open Face X 60". Solid Pin Center, can be cut to any Length. Screws are sold Separately

- 54 350 Continuous Hinge@

HINGE PINS



54 352A Various sizes of "L" shaped hinge pins are available.

.....each

UPRIGHT PIANO LOCK

Brass. Triangle Key and Escutcheon included.

- 54 356B Upright Piano LockEach
- 54 357A Key only



HANDS OFF" PIANO FALLBOARD LOCK

External Universal Fallboard Lock. Fits most fallboards that lift to open. Great for Schools and Churches. Easy to install.

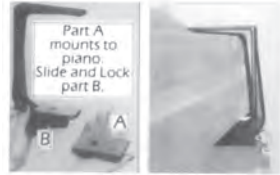

54 356 Piano Fallboard Lock each

GRAND DESK RESTS

Grand Desk Rest Comes with Hook and Tip.



54 360 Grand Desk Rest, Brass @

GRAND DESK SUPPORT HINGE

Measures 9" long x 1" wide.



54 362 Grand Desk Support Hinge, Heavy Brass @

GRAND LID SUPPORT

Grand Lid Support. 12" Long. Support Cup Sold Separately.



54 363B Grand Lid Support Brass @
54 364 Support Cup Brass @

LYRE BRACES

Grand Pedal Lyre Braces. Brass Plated.



54 367A Short Lyre Braces 13" Pr.
54 367B Long Lyre Braces 21" Pr.

BACKORDER POLICY

Items not in stock will be placed on backorder, unless the item is under \$10.00, in which case it is cancelled automatically.

You may request "No Backorders."

There is no Handling Charge for Backordered items.

Backorders not filled within 90 days will be cancelled.

MUSIC DESK HINGE

For Spinets. Sold by the Pair, with screws.



54 382 Music Desk Hinge Pair

QUIET KEYS SYSTEM

In response to demand created by the import piano market, we are proud to announce the addition of the *improved* Quiet Keys mute to our product line. This system allows you to add a complete muffler rail system to any vertical piano.



Easily installed, Quiet Keys mounts over two tuning pins, and adjusts to fit spinets as easily as consoles, studios, and uprights. Complete with everything for installation, including the control cable, Quiet Keys is constructed to provide a life-time of trouble free operation. Piano appearance and normal function are not affected. When "on", Quiet Keys places an acrylic felt muting strip between hammers and strings. There is none of the affect on playability often associated with end panel mounted mutes. For tuning, Quiet keys can be instantly removed from the pins, and as quickly replaced when finished.

54 366Q Quiet Keys System@

SCREWS AND HARDWARE

68 393C Brass Screws 5/8" x 4 Pkg. 100

SPRINGS



57 317M Medium Trap Spring 4"@
57 319 Trap Lever@

RUBBER BUTTON ASSORTMENT KIT

Assortment of all styles of quality Buttons and Nails in 17 compartment organizer.



58 201 Rubber Button Assortment Kit.....

RUBBER NAIL HEADS

58 265 Black Per C
58 265B Brown Per C
58 266 Black Per C
58 266B Brown Per C
58 267 Black Per C
58 267B Brown Per C

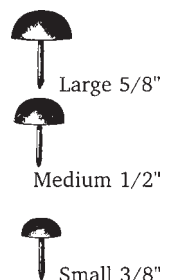

Rubber Nail Heads continued...

58 265Q Quality Large Black Rubber Nails Per C



58 266Q Quality Medium Black Rubber Nails Per C



58 267Q Quality Small Black Rubber Nails Per C



RUBBER BUTTONS

58 271 Black Per C



Large

58 271B Brown Per C

58 270 Black Per C



Small

58 270B Brown Per C

58 272A Small Per C



58 272B Medium Per C

58 272C Large Per C

Black PlungerType

WOOD FALLBOARD KNOBS

58 274 Wood Fallboard Knobs Pair

BRASS KNOBS

Screw End Knob

58 277A 1/2" Pair

58 277B 5/8" Pair



BRIDLE TAPES

All Part Numbers Sold By the Set.



59 535 Plain Bridle Tapes Set

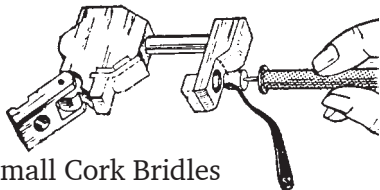

59 536AS Small Cork Bridles Set

59 536AM Medium Cork Bridles Set

59 536AL Large Cork Bridles Set

SPRING CLIP BRIDLES



59 536B Spring Clip BridlesSet

MAPLE HAMMER SHANKS



59 532A Upright Shanks 7/32" Dia. 100

59 532C Spinet Shanks 3/16" Dia. 100

"HOT STUFF" GLUE SYSTEM

Excellent adhesives for piano repairs.



- 73 9 Accelerator Spray Can** 6 oz.
- 73 10 Pro Tips Extension Applicators**
- 73 11 Accelerator**

An EXTREMELY FAST Accelerator for all "HOT STUFF" instant glues. Contains special ingredients that clean the bonding surface, for a stronger, longer lasting bond. KICK-IT has an extraordinary on-part life. Parts may be sprayed up to 10 minutes in advance of bonding. Use sparingly, a little goes a long way.

73 12 SUPER SOLVENT
Use this solvent to clean up after using "HOT STUFF." See CLEAN-UP for information.

73 13 GREEN SPECIAL T

A thick cyanocrylate glue with a consistency resembling cold honey. SPECIAL T has a greater gap filling ability than SUPER T. Parts are more easily positioned after contact. Rate of cure (50-60 seconds) is slow enough to allow precision placement of parts after assembly. Use for broken keys, damper felts, split bridges, etc.



73 14 ORANGE SUPER T

SUPER T has a faster cure rate than SPECIAL T (10-25 seconds, depending on material). Syrupy in consistency, it will fill small gaps between parts with imperfect fit. Try this for broken keys, hammer shanks, loose key tops, gluing grand knuckles, bridle straps, split bridges, soundboards, refelting plates, or broken wippen.



73 15 RED HOT STUFF INSTANT GLUE

Instant bonding, thin consistency like water. Use only for parts which fit very well. Use for jack flanges on older uprights, loose ivories, gluing rubber buttons on polyester surfaces, loose bridge pins or spoons, soundboards, bridle strap posts, backcheck posts, loose hammer heads or key weights, or as a sealer for polyester repair.



73 16 "HOT TIPS" OVERCAPS

73 17 SPRAY PUMPS ONLY FOR ACCELERATOR

FAX US YOUR ORDER (818) 700-2104

MCLUBE

73 1725L Clear Aerosol@

73 MAC-480 Aerosol@

A dry, nearly invisible, durable release surface. It can be applied to a clean, dry surface, by spraying, dipping, or wiping. Apply a thin coat over the entire surface, and allow to dry; then apply a second coat. Useful for lubricating key pins, capstans, key frames, pedal springs, and trapwork.



73 PL ProLube (4 oz. bottle - pump sprayer).

CENTER PIN LUBE & CLEANER

Protek™ center pin cleaner / lubricant. Removes verdigris and protects against future build-up by coating the center pin and sealing the cloth from moisture. Will not travel, dry out, nor attract dust.



4 oz.



Quart

73 PRO Proteck 4 oz. @

73 PROQ Proteck Quart ... @

73 MPL-1 Proteck Multi-Purpose Lube

Clean, high-teck grease-type lubricant which does not dry out. Use on all wood-to-wood, wood-to-metal, and metal-to-metal applications. Ideal for trapwork.

DAG LIQUID GRAPHITE

4 oz. Jar. Thin with Alcohol, or Lacquer thinner. Dries Fast! A clean and efficient way to re-graphite Jacks, Bridges, Pedal and Action Springs.

73 284A Dag Liquid Graphite@

TEFLON POWDER

This clean powder is great for Grand Knuckles, Pedals, Springs, etc.

73 284T Teflon Powder, 3.5 oz. jar



**Before You Dial The Phone...
Do You Have Your Part Numbers?**

PLASTIC OILERS

73 92H Metal Spout Hypo Oiler

..... @



MOLDED KEY TOPS

75 292 Molded White Key Tops .070 Thick

..... 52

75 292V Molded White Key Tops .075 Thick

..... 52



MOLDED KEY TOP W/FRONTS

All Molded Keytops are sold by the set only.

75 292T Molded Key Top w/Fronts52

PLASTIC HEADS AND TAILS

Replacement for Ivory Two-Piece Keys. (Ivory is no longer available). White or Yellow, sold by each.

75 288PHW Plastic Key Head (White) @

75 288PTW Plastic Key Tail (White) @

75 288PHY Plastic Key Head (Yellow) @

75 288PTW Plastic Key Tail (Yellow) @

BACKORDER POLICY

Items not in stock will be placed on backorder, unless the item is under \$10.00, in which case it is cancelled automatically.

You may request "No Backorders."

There is no Handling Charge for Backordered items. Backorders not filled within 90 days will be cancelled.

PLASTIC SHARPS

75 286 Plastic Sharps 3-1/2"36

PLASTIC KEY CEMENT

Formulated especially for our Molded Plastic Key Tops. 4 oz. jar.

75 294A Plastic Key Cement@

75 294G Plastic Key Cement - Gallon@

BUFFING PADS



The finest quality pads. For use on motors not to exceed 5000 rpm. Floppy wheel for Plastic, Sewn wheel for Brass. Four pads are recommended per mount. Sold by the each.

75 222 Plastic Buffing Pad 10" Dia. x 1/2" Thick. Each

75 223 Brass Buffing Pad 10" Dia. x 1/2" Thick. Each

BUFFING COMPOUNDS

75 221B White Rouge 2-1/2 Lb. Brick For Ivory or Plastic. Each

75 220-2 Tripoli 2-1/2 Lb. Brick For Brass. Each

KEY PINS

Sold by Each.



75 323 Key Pins Oval Front@

75 324 Key Pins Round Balance@

ROUND KEY LEADS

75 326 Round Key Leads 3/8" D. (per 90)

75 327 Round Key Leads 1/2" D. (per 90)

75 328 Round Key Leads 5/8" D. (per 90)

SCREW ON "JIFFY LEADS"

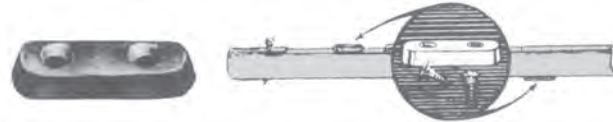

Jiffy Leads with Screws (sold by the each)

75 329 Screw On Jiffy Leads @

KEY SERVICES

01 KCT Keys Recovered

01 SHARPS Plastic Sharps Installed.....

01 REBUSH BR Rebush Balance Rail.....

01 REBUSH FR Rebush Front Rail

POLYESTER POLISH "The Original"

For all pianos with "Hi-Gloss" Finishes. Formulated for plastic finishes, this product leaves a microscopic coating that repels dust, dirt, finger prints, and airborne particles. 8 oz. Plastic Pump-Spray.

80 MTK8 Polyester Polish 8 oz. Bottle Per case of 12



Professional Key Rebushing (complete job)

For Grands:

- Send in the Keys on the Frame.
- We will Rebush, clean the Frame and the ins.
- No easing will be necessary!
- **We guarantee a perfect fit!**

For Uprights:

- Give us the diameter of the Front and Balance Pins. Since we do not have the Key Frame - some fitting may be required.

Call for details - 818-700-2100

BOOKS AND REFERENCE MANUALS



91 RB12 Pierce Piano Atlas

91 RB62 Piano Tuning, Servicing, and Rebuilding (Reblitz)

BENCHES



99 I Piano Bench

Straight tapered leg. Upholstered top with storage compartment.

Available in Ebony, Walnut and Mahogany.

Before You Dial The Phone... Did you MEASURE The Piano? The measurement for a Grand is the LONG-EST AXIS of the Piano, from the Top of The Arc of the Case to The Front Edge of the Keyboard. On a Vertical Piano, Measure from The Floor to the Top, and Subtract 1".

PIANO COVERS (See measuring below)

99 COV Vinyl Covers
Available by Special Order.

CANVAS (MACINTOSH)
These canvas dust covers are sewn from black cotton fabric with fleece lining.



GRAND CANVAS PIANO COVERS

- 99 GR52** Canvas Cover 5'2"
- 99 GR54** Canvas Cover 5'4"
- 99 GR56** Canvas Cover 5'6"
- 99 GR57** Canvas Cover 5'7"
- 99 GR58** Canvas Cover 5'8"
- 99 GR59** Canvas Cover 5'9"
- 99 GR5105** Canvas Cover 5'10½"
- 99 GR60** Canvas Cover 6'0"
- 99 GR63** Canvas Cover 6'3"
- 99 GR645** Canvas Cover 6'4½"
- 99 GR67** Canvas Cover 6'7"
- 99 GR68** Canvas Cover 6'8"
- 99 GR70** Canvas Cover 7'0"
- 99 GR74** Canvas Cover 7'4"
- 99 GR75** Canvas Cover 7'5"
- 99 GR76** Canvas Cover 7'6"
- 99 GR90** Canvas Cover 9'0"

UPRIGHT CANVAS PIANO COVERS

- 99 SP3** Spinet Cover 3'0"
- 99 SP34** Spinet Cover 3'4"
- 99 UP37** Upright Cover 3'7"
- 99 UP38** Upright Cover 3'8"
- 99 UP310** Upright Cover 3'10"
- 99 UP40** Upright Cover 4'0"
- 99 UP44** Upright Cover 4'4"
- 99 UP46** Upright Cover 4'6"
- 99 UP48** Upright Cover 4'8"
- 99 UP410** Upright Cover 4'10"

GRAND PADDED COVERS

These Heavy Quilted Covers have Locking Straps. Thick Cotton Black Canvas.

- 99 PGR52** Padded Cover 5'2"
- 99 PGR58** Padded Cover 5'8"
- 99 PGR60** Padded Cover 6'0"
- 99 PGR63** Padded Cover 6'3"
- 99 PGR68** Padded Cover 6'8"
- 99 PGR7** Padded Cover 7'0"
- 99 PGR75** Padded Cover 7'5"
- 99 PGR9** Padded Cover 9'0"

Index

A

ACTION CRADLE **27**
ACTION PARTS **6-24**
ACTION PARTS, Tokiwa **6-24**
AGRAFFE, Wrench **30**
AGRAFFES, Grand **30**

B

BASS STRINGS, Individual Universal **31**
BASS STRINGS, Universal Replacement **31**
BASS STRINGS. Custom **31**
BENCHES **41**
BOOKS AND REFERENCE MANUALS **41**
BRIDLE TAPES **38**
BRIDLES, Spring Clip **38**
BUFFING COMPOUNDS **40**
BUFFING PADS **40**
BURNISHER, Tapered **28**

C

CANVAS TOOL ROLL, Large **27**
CANVAS TOOL ROLL, Small **27**
CAPSTAN WRENCHES **27**
CASTER CUPS, Plastic - Wood **33**
CASTERS, Brass Spinnet **34**
CASTERS, Double Wheel Rubber **34**
CASTERS, Grand Brass **34**
CASTERS, Upright **33**
CENTER PIN LUBE & CLEANER **39**
CENTER PIN PLIERS **28**
CENTER PINS **28**
CHECKERING FILE **32**
CLOTH, Action **36**
CLOTH, Back Rail **35**
CLOTH, Flange Bushing **35**
CLOTH, Key Bushing **35**
CLOTH, Upright Hammer Rail **36**
COMBINATION HANDLE **26**

D

DAG LIQUID GRAPHITE **39**
DAMPER FELTS, Grand **7**
DAMPER REGULATOR **26**
DEHUMIDIFIERS **4**
DELUXE PINBLOCK SUPPORT **29**
DOLLIES, Grand Leg **34**
DOLLIES, Twin **34**
DOLLIES, Twin Heavy duty **35**
DOLLY, Grand Piano Stage **34**
DROP SCREW REGULATOR **22**

E

ELBOWS, WOOD **22**
ELECTRICAL OUTLETS **4**

F

FELT CUTTER (Maple) **36**
FELT, Flat Grand Damper **36**
FELT, Flat Upright Damper **36**
FELT, Grand Damper (Set) **36**

FELT, Grand Damper (Strips) **36**
FELT, Grand Hammer Rest **36**
FELT, Grand Understring **36**
FELT, Hammer Butt **36**
FELT, Muffler Rail **36**
FELT, Nameboard **35**
FELT PICKER, Combo-handle **32**
FELT PICKER. Adjustable **32**
FELT PUNCHINGS, Front Rail Woven **35**
FELT, Spring Rail **36**
FELT, Upright Bass Damper **32**
FLANGE BUSHING BROACH KIT **28**
FLUSH CUT PIN NIPPERS **28**

G

GLUE, Ground **39**
GLUE SYSTEM, "Hot Stuff" **38**
GRAM WEIGHTS **27**
GRAND DESK RESTS **37**
GRAND DESK SUPPORT HINGE **37**
GRAND IN-PIANO LET-OFF REGULATING TOOL **27**
GRAND KEY LEVELING LEADS **27**
GRAND LID SUPPORT **37**
GRAND SHANK PRESS **32**

H

HAMMER, CUSTOM BORING & SHAPING **5**
HAMMER SHANK REDUCER **26**
HAMMER SHANKS, Maple **38**
HAMMERS, Pacific Gold Label **5**
HAMMERS, Upright **6**
HART SPRING TOOL **27**
HINGE, Music Desk **36**
HINGE PINS **36**
HINGES **36**
HUMIDIFIER PADS **4**
HUMIDIFIER TREATMENT **4**
HUMIDIFIERS, Vertical **3**
HUMIDIFIERS. Grand **3**
HUMIDISTATS **3**

I

IMPACT COIL LIFTER & SETTER **30**
IRON, Hammer electric **32**

K

KEY DIP BLOCK, (3/8") **27**
KEY HEADS AND TAILS, Plastic **39**
KEY LEADS, Round **40**
KEY PINS **40**
KEY RAIL EASERS **24**
KEY REBUSHING, Professional **24**
KEY SERVICES **40**
KEY TOP w/Fronts. Molded **39**
KEY TOPS, Molded **39**
KNOBS, Brass **38**
KNOBS, Wood Fallboard **38**

L

LEG PLATES, Grand **33**
 LOCKS **36-37**
 LYRE BRACES **37**

M

MAPLE WOOD PLATE BUSHINGS **29**
 MCLUBE **39**
 MICROMETERS, Starrett **30**
 MUSIC WIRE GAUGE, Starrett **30**
 MUTES, Split **26**
 MUTES, Papps **26**
 MUTES, Stick **26**
 MUTES, Rubber Tuning **25**

O

OFFSET KEY SPACER **26**
 OILERS, Plastic **39**

P

PEDAL BRACKETS **33**
 PEDAL PINS **33**
 PEDAL RODS, Brass **33**
 PEDALS, Grand (Set of 3) **33**
 PEDALS, Upright (Set of 3) **33**
 PIANO COVERS **41**
 PIANO LIFE SAVER SYSTEMS **3**
 PIANO SYSTEMS, Grand **3**
 PIANO SYSTEMS, Vertical **3**
 PIANO WIRE **28-29**
 PLATE BUSHING PUNCH **30**
 PLIERS, Key Easing **32**
 PLIERS, Regulating **32**
 PLIERS, Round Nose **32**
 PLIERS, Shank Knurling **32**
 POLISH, "The Original" Polyester **40**
 POLITA STEEL POLISH CAKE **30**
 POWER PIN SOCKET **25**
 PUNCHINGS, Felt Balance Rail **35**
 PUNCHINGS, Hitch Pin **35**
 PUNCHINGS, Paper Balance Rail **35**
 PUNCHINGS, Paper Front Rail **35**
 PUNCHINGS, Regulating Button **35**

Q

QUIET KEYS SYSTEM **37**

R

RAT TAIL FILE **28**
 RATCHET HEAD **25**
 REGULATING KIT **27**
 REGULATING SCREWDRIVER **26**
 REPINNING TOOL **28**
 RUBBER BUTTON ASSORTMENT KIT **37**
 RUBBER BUTTONS **38**
 RUBBER NAIL HEADS **37-38**
 RUBBER TUNING MUTES **25**

S

SANDPAPER FILE **32**
 SCREW ON JIFFY LEADS **40**
 SCREWDRIVER, Action Flange **26**
 SCREWDRIVER, Kimball **26**
 SCREWDRIVER, Medium Piano **26**
 SCREWDRIVER, Phillips 8" **24**
 SCREWDRIVERS **24**
 SHARPS, Plastic **40**
 SHIMMING KNIFE **30**
 SOUNDBOARD CLEANER **27**
 SOUNDBOARD SHIMS **30**
 SPRINGS **37**
 STARRETT PIN VISE **28**
 STEINWAY STYLE UPRIGHT PARTS **23A, 23B**
 STRING HOOK **31**
 STRING LIFTER AND SPACER **31**
 STRINGING BRAID, Scarlet **30**

T

TAPERED REAMER **28, 32**
 TEFLON POWDER **39**
 TEMPERAMENT FELTS **26**
 TIP WRENCH **25**
 TRUCK, Spinet **34**
 TUNING FORKS, Sheffield **26**
 TUNING HAMMER, Extension **25**
 TUNING HAMMER, Gooseneck **25**
 TUNING HAMMER, Non-Extending **25**
 TUNING HEADS **25**
 TUNING KIT, Basic **25**
 TUNING PIN CRANK **31**
 TUNING PIN GAUGE **31**
 TUNING PIN PUNCH **30**
 TUNING PIN TIGHTENER **29**
 TUNING PINS **29**
 TUNING HAMMER, Mini **24**
 TWEEZERS **27**

U

UPRIGHT HAMMER AND BUTT EXTRACTOR **33**

V

VERTICAL SPOON BENDER **26**
 VOICING TOOL: "HART"; and Ultimate **32**

W

WATERING KIT **4**
 WIRE **28-29**
 WIRE CANISTER **29**
 WIRE CUTTERS **31**



pacific piano
supply company

Phone: (818) 700-2100

FAX: (818) 700-2104 (24 Hours)

E-mail: Sales@pacificpiano.com

**9424 Eton Avenue — Unit C
Chatsworth, CA 91311**